

ONE BOARDLOCK
(LEFT)

- NOTE:
- MATERIAL:
HOUSING: PA9T, UL94 V-0, COLOR: (SEE TABLE).
CONTACTS: BRASS.
 - FINISH:
CONTACTS: 3.05um [120u"] MIN. MATTE-TIN.
1.27um [50u"] MIN. NICKEL UNDERPLATED ALL OVER.
 - WAVE SOLDER CAPABLE TO 265°C PER TEST SPEC.
109-202, CONDITION B.
 - NO TE LOGO AND DATE CODE ON THE PRODUCT WITH 4 POS.
 - THE KEY IDENTIFIED WAS SHOWN ON PAGE 5.

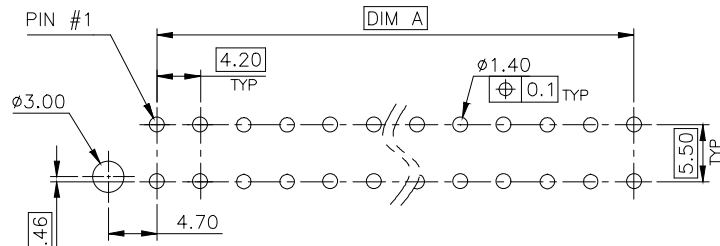

RECOMMENDED PCB LAYOUT
TOLERANCE: ±0.05 T=1.6mm

BLACK PA9T	1.52	8.4	13.7	15.75	6	6-5099-6
IVORY PA9T	5.40	46.2	51.5	53.55	24	1-5099-3
	1.13	4.2	9.5	11.55	4	1-5099-2
	4.30	37.8	43.1	45.15	20	1-5099-1
	3.90	33.6	38.9	40.95	18	1-5099-0
	3.11	25.2	30.5	32.55	14	5099-9
	2.71	21.0	26.3	28.35	12	5099-8
	2.31	16.8	22.1	24.15	10	5099-7
	1.52	8.4	13.7	15.75	6	5099-6
1.92	12.6	17.9	19.95	8	5099-5	
HSG COLOR & MATERIAL	WEIGHT	DIM A	DIM B	DIM C	POS.	PART NUMBER

				TOLERANCE		UMax conn 东莞市友贸实业有限公司 DONGGUAN UMAXCONN ENTERPRISE LIMITED		TITLE: ATX POWER CONNECTOR 4.2mm PITCH, VERTICAL, DIP TYPE				
				LINEAR	ANGLES			PART NO. SEE TABLE				
				X±0.40	X°±	APPD: Jason	MAT'L:	DWG NO. C-5099				
				.X±0.30	.X°±	CHKD: Schumi	FINISH:		UNITS	SCALE	SHEET	REV
REV	ECN NO.	NAME	DATE	.XX±0.20	.XX°±	DRWN: Terry	Q'TY:		MM	1 : 1	1 OF 6	0
				.XXX±0.10	.XXX°±					CUSTOMER		

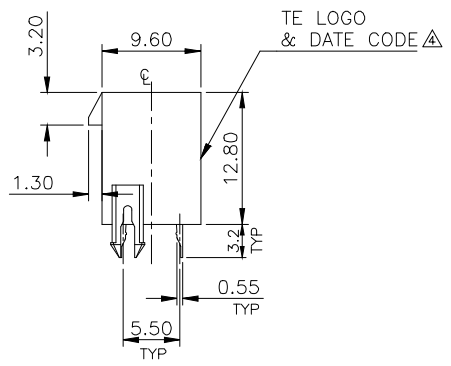
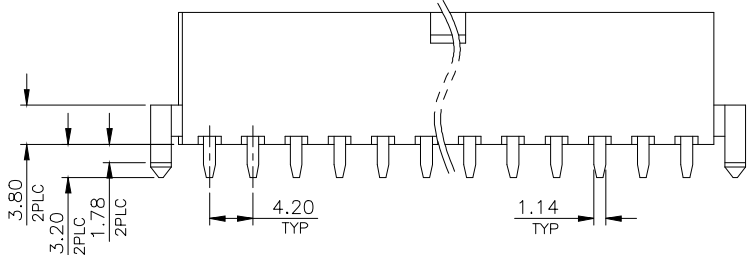
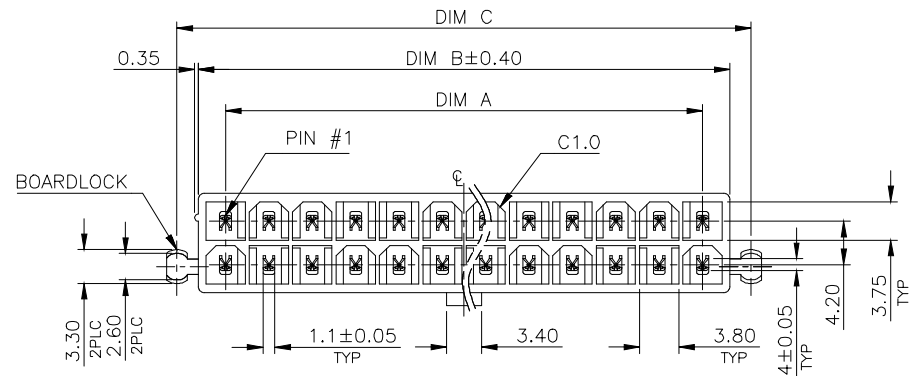

TWO BOARDLOCK

- NOTE:
- MATERIAL:
HOUSING: PA9T, UL94 V-0, COLOR: (SEE TABLE).
CONTACTS: BRASS.
 - FINISH:
CONTACTS: 3.05um [120u"] MIN. MATTE-TIN.
1.27um [50u"] MIN. NICKEL UNDERPLATED ALL OVER.
 - WAVE SOLDER CAPABLE TO 265°C PER TEST SPEC.
109-202, CONDITION B.
 - NO TE LOGO AND DATE CODE ON THE PRODUCT WITH 4 POS.
 - THE KEY IDENTIFIED WAS SHOWN ON PAGE 5.

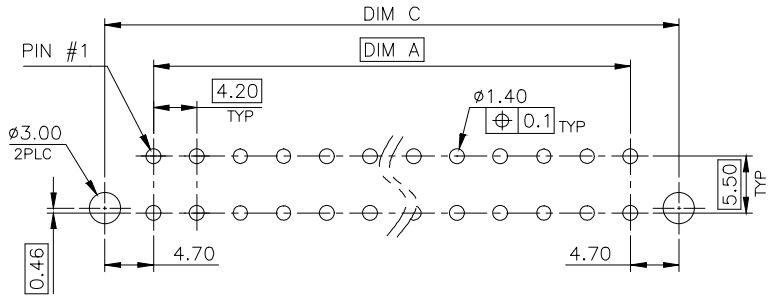

RECOMMENDED PCB LAYOUT
TOLERANCE: ±0.05 T=1.6mm

IVORY PA9T	3.54	29.4	34.7	38.8	16	2-5099-9
	5.43	46.2	51.5	55.6	24	2-5099-8
	4.33	37.8	43.1	47.2	20	2-5099-7
	3.93	33.6	38.9	43.0	18	2-5099-6
	3.14	25.2	30.5	34.6	14	2-5099-5
	2.74	21.0	26.3	30.4	12	2-5099-4
	2.34	16.8	22.1	26.2	10	2-5099-3
	1.95	12.6	17.9	22.0	8	2-5099-2
	1.55	8.4	13.7	17.8	6	2-5099-1
1.16	4.2	9.5	13.6	4	2-5099-0	
HSG COLOR & MATERIAL	WEIGHT	DIM A	DIM B	DIM C	POS.	PART NUMBER

				TOLERANCE		UMax conn 东莞市友贸实业有限公司 DONGGUAN UMAXCONN ENTERPRISE LIMITED		TITLE: ATX POWER CONNECTOR 4.2mm PITCH, VERTICAL, DIP TYPE				
				LINEAR	ANGLES			PART NO. SEE TABLE				
				X±0.40	X°±	APPD: Jason	MAT'L:	DWG NO. C-5099				
				.X±0.30	.X°±	CHKD: Schumi	FINISH:		UNITS	SCALE	SHEET	REV
REV	ECN NO.	NAME	DATE	.XX±0.20	.XX°±	DRWN: Terry	Q'TY:		MM	1 : 1	2 OF 6	0
				.XXX±0.10	.XXX°±					CUSTOMER		

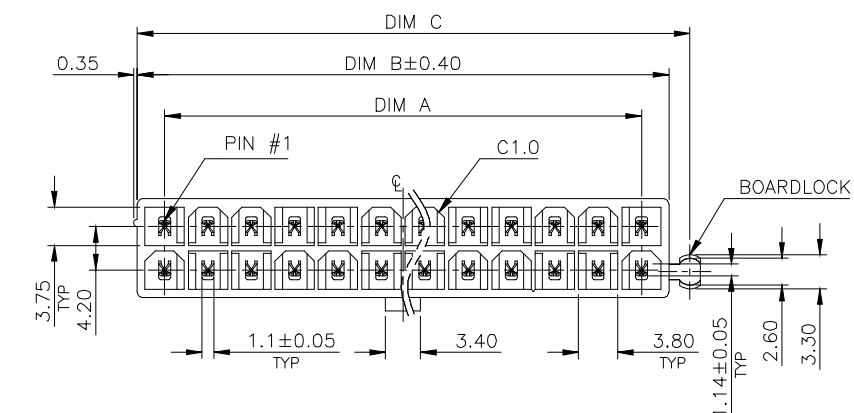

- NOTE:
- MATERIAL:
HOUSING: PA9T, UL94 V-0, COLOR: (SEE TABLE).
CONTACTS: BRASS.
 - FINISH:
CONTACTS: 3.05um [120u"] MIN. MATTE-TIN.
1.27um [50u"] MIN. NICKEL UNDERPLATED ALL OVER.
 - WAVE SOLDER CAPABLE TO 265°C PER TEST SPEC.
109-202, CONDITION B.
- ⚠ NO TE LOGO AND DATE CODE ON THE PRODUCT WITH 4 POS.
5. THE KEY IDENTIFIED WAS SHOWN ON PAGE 5.

ONE BOARDLOCK (RIGHT)

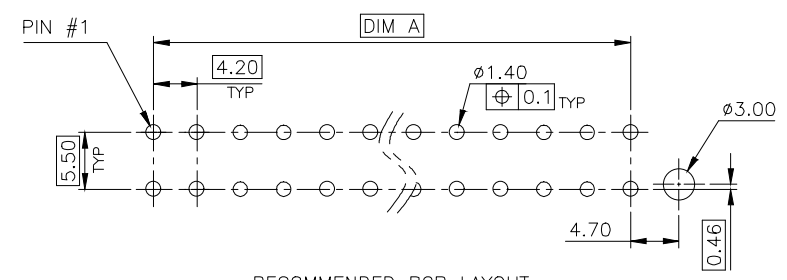
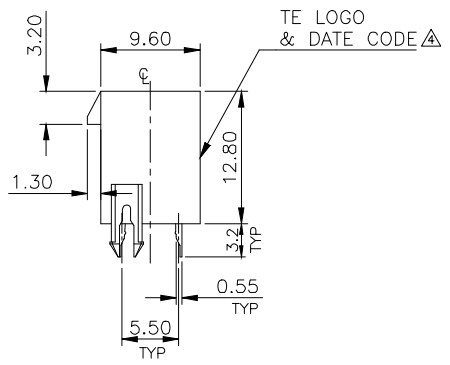
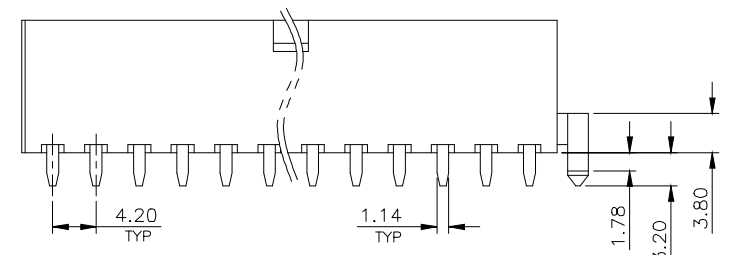

RECOMMENDED PCB LAYOUT
TOLERANCE: ±0.05 T=1.6mm

IVORY PA9T	5.40	46.2	51.5	53.55	24	3-5099-8
	4.30	37.8	43.1	45.15	20	3-5099-7
	3.90	33.6	38.9	40.95	18	3-5099-6
	3.11	25.2	30.5	32.55	14	3-5099-5
	2.71	21.0	26.3	28.35	12	3-5099-4
	2.31	16.8	22.1	24.15	10	3-5099-3
	1.92	12.6	17.9	19.95	8	3-5099-2
	1.52	8.4	13.7	15.75	6	3-5099-1
	1.13	4.2	9.5	11.55	4	3-5099-0
HSG COLOR & MATERIAL	WEIGHT	DIM A	DIM B	DIM C	POS.	PART NUMBER

				TOLERANCE		UMax conn 东莞市友贸实业有限公司 DONGGUAN UMAXCONN ENTERPRISE LIMITED		TITLE: ATX POWER CONNECTOR 4.2mm PITCH, VERTICAL, DIP TYPE				
				LINEAR	ANGLES			PART NO. SEE TABLE				
				X±0.40	X°±	APPD: Jason	MAT'L:	DWG NO. C-5099				
				.X±0.30	.X°±	CHKD: Schumi	FINISH:		UNITS	SCALE	SHEET	REV
REV	ECN NO.	NAME	DATE	.XX±0.20	.XX°±	DRWN: Terry	Q'TY:		MM	1 : 1	3 OF 6	0
				.XXX±0.10	.XXX°±			CUSTOMER				

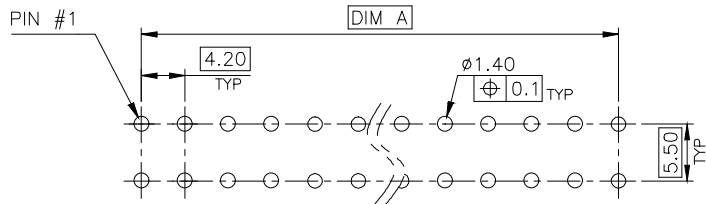
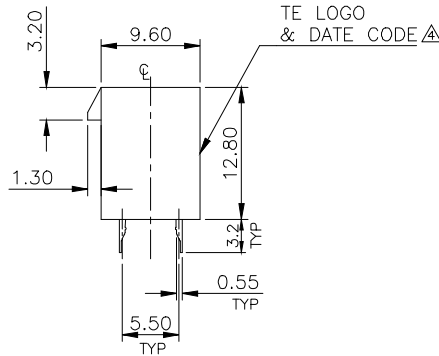
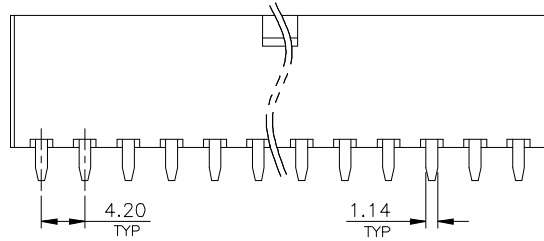
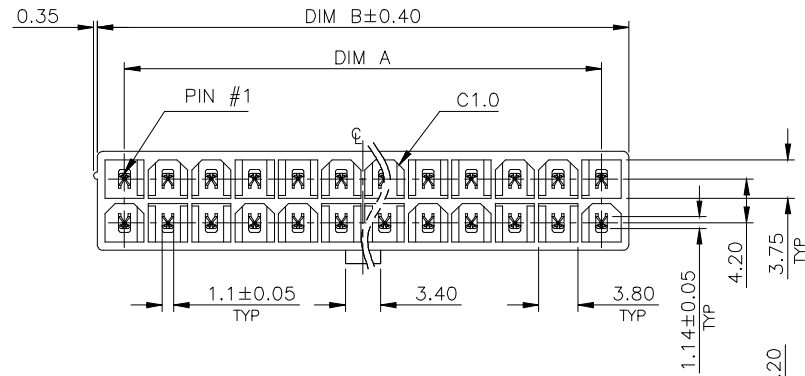

RECOMMENDED PCB LAYOUT
TOLERANCE: ±0.05 T=1.6mm

NOTE:

1. MATERIAL:
HOUSING: PA9T, UL94 V-0, COLOR: (SEE TABLE).
CONTACTS: BRASS.
2. FINISH:
CONTACTS: 3.05um [120u"] MIN. MATTE-TIN.
1.27um [50u"] MIN. NICKEL UNDERPLATED ALL OVER.
3. WAVE SOLDER CAPABLE TO 265°C PER TEST SPEC.
109-202, CONDITION B.
- △ NO TE LOGO AND DATE CODE ON THE PRODUCT WITH 4 POS.
5. THE KEY IDENTIFIED WAS SHOWN ON PAGE 5.

NO BOARDLOCK

IVORY PA9T	5.37	46.2	51.5	24	4-5099-8
	4.27	37.8	43.1	20	4-5099-7
	3.87	33.6	38.9	18	4-5099-6
	3.08	25.2	30.5	14	4-5099-5
	2.68	21.0	26.3	12	4-5099-4
	2.28	16.8	22.1	10	4-5099-3
	1.89	12.6	17.9	8	4-5099-2
	1.49	8.4	13.7	6	4-5099-1
	1.10	4.2	9.5	4	4-5099-0
HSG COLOR & MATERIAL	WEIGHT	DIM A	DIM B	POS.	PART NUMBER

				TOLERANCE		UMax conn 东莞市友贸实业有限公司 DONGGUAN UMAXCONN ENTERPRISE LIMITED		TITLE: ATX POWER CONNECTOR 4.2mm PITCH, VERTICAL, DIP TYPE				
				LINEAR	ANGLES			PART NO. SEE TABLE				
				X±0.40	X°±	APPD: Jason	MAT'L:	DWG NO. C-5099				
				.X±0.30	.X°±	CHKD: Schumi	FINISH:		UNITS	SCALE	SHEET	REV
REV	ECN NO.	NAME	DATE	.XX±0.20	.XX°±	DRWN: Terry	Q'TY:		MM	1 : 1	4 OF 6	0
				.XXX±0.10	.XXX°±							

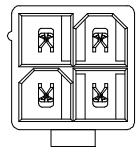

4 POS

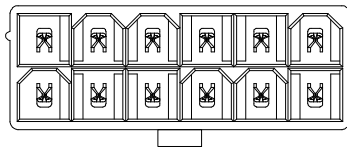

12 POS

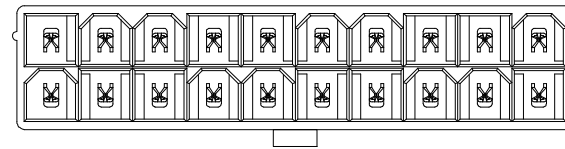

20 POS

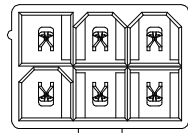

6 POS

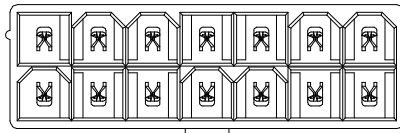

14 POS

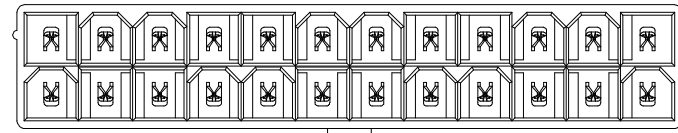

24 POS

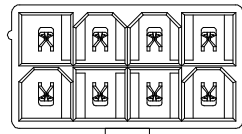

8 POS

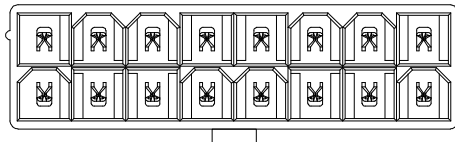

16 POS

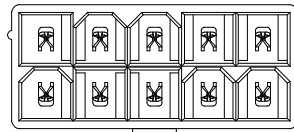

10 POS

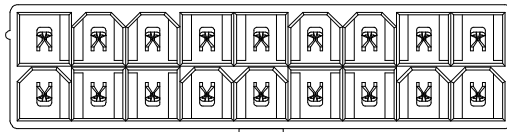

18 POS

KEY POSITION IDENTIFIED
(TOP VIEW)

REV	ECN NO.	NAME	DATE

TOLERANCE	
LINEAR	ANGLES
X \pm 0.40	X $^{\circ}$ \pm
.X \pm 0.30	.X $^{\circ}$ \pm
.XX \pm 0.20	.XX $^{\circ}$ \pm
.XXX \pm 0.10	.XXX $^{\circ}$ \pm

UMax conn 东莞市友贸实业有限公司
DONGGUAN UMAXCONN ENTERPRISE LIMITED

APPD: Jason MAT'L:
CHKD: Schumi FINISH:
DRWN: Terry Q'TY:

TITLE: ATX POWER CONNECTOR
4.2mm PITCH, VERTICAL, DIP TYPE

PART NO. SEE TABLE
DWG NO. C-5099

UNITS	SCALE	SHEET	REV
MM	1 : 1	5 OF 6	0

A

B

C

D

E

A

B

C

D

E

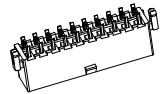
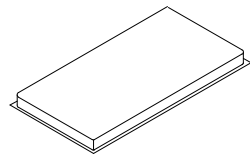

QUANTITY SEE TABLE

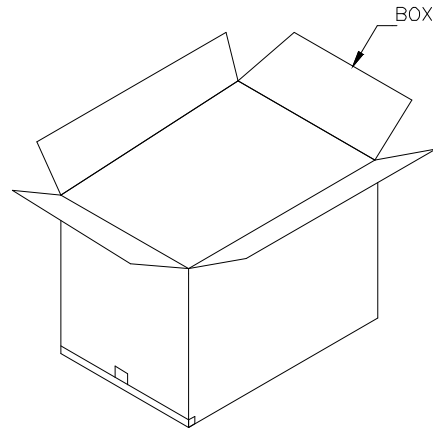
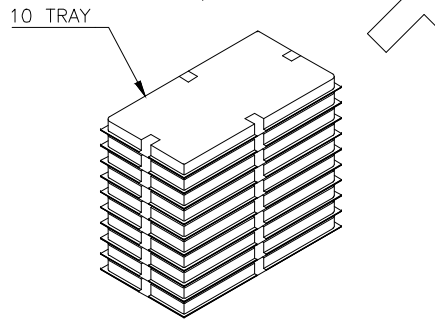
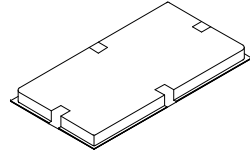
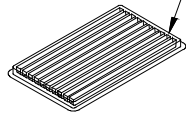

BOX

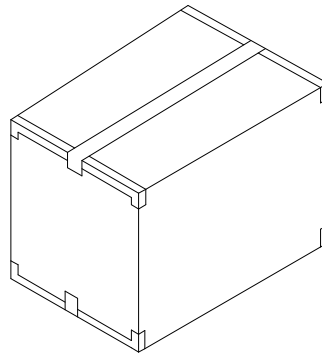

NOTES:

- 1. TRAY : PVC, SIZE: 330mm(L)X 265mm(W)X 22mm(H).
- 2. BOX : CORRUGATED, SIZE: 350mm(L)X 279mm(W)X 195mm(H).
- 3. QUANTITY: SEE TABLE.

5.94	4.34	80	10	800	24	2
5.93	4.33	100	10	1000	20	
5.53	3.93	100	10	1000	18	
5.85	4.25	120	10	1200	16	
6.00	4.40	140	10	1400	14	
5.98	4.38	160	10	1600	12	
5.81	4.21	180	10	1800	10	
5.89	4.29	220	10	2200	8	
5.94	4.34	280	10	2800	6	
5.78	4.18	360	10	3600	4	
5.92	4.32	80	10	800	24	1
5.90	4.30	100	10	1000	20	
6.28	4.68	120	10	1200	18	
5.95	4.35	140	10	1400	14	
5.94	4.34	160	10	1600	12	
6.22	4.62	200	10	2000	10	
6.21	4.61	240	10	2400	8	
6.16	4.56	300	10	3000	6	
6.35	4.75	420	10	4200	4	
5.90	4.30	80	10	800	24	
5.87	4.27	100	10	1000	20	
6.24	4.64	120	10	1200	18	
5.91	4.31	140	10	1400	14	
6.42	4.82	180	10	1800	12	
6.16	4.56	200	10	2000	10	
6.51	4.91	260	10	2600	8	
6.67	5.07	340	10	3400	6	
6.88	5.28	480	10	4800	4	
GROSS WEIGHT	NET WEIGHT	PCS /TRAY	TRAYS /BOX	PCS /BOX	POS.	NO. OF BOARDLOCK

REV	ECN NO.	NAME	DATE	TOLERANCE	
				LINEAR	ANGLES
				X±0.40	X°±
				.X±0.30	.X°±
				.XX±0.20	.XX°±
				.XXX±0.10	.XXX°±

UMax conn 东莞市友贸实业有限公司
DONGGUAN UMAXCONN ENTERPRISE LIMITED

APPD: Jason MAT'L:

CHKD: Schumi FINISH:

DRWN: Terry Q'TY:

TITLE: ATX POWER CONNECTOR
4.2mm PITCH, VERTICAL, DIP TYPE

PART NO. SEE TABLE

DWG NO. C-5099

UNITS	SCALE	SHEET	REV
MM	1 : 1	6 OF 6	0