

10MHz, Rail-to-Rail I/O CMOS Operational Amplifier

FEATURES

- **HIGH GAIN BANDWIDTH:10MHz**
- **RAIL-TO-RAIL INPUT AND OUTPUT**
1mV Typical Vos
- **INPUT VOLTAGE RANGE: -0.1V to +5.6V**
with Vs = 5.5V
- **SUPPLY RANGE: +2.5V to +5.5V**
- **SPECIFIED UP TO +125°C**
- **MicroSIZE PACKAGES: SOT353(SC70-5)**

APPLICATIONS

- **SENSORS**
- **PHOTODIODE AMPLIFICATION**
- **ACTIVE FILTERS**
- **TEST EQUIPMENT**
- **DRIVING A/D CONVERTERS**

DESCRIPTION

The RS721 offer low voltage operation and rail-to-rail input and output, as well as excellent speed/power consumption ratio, providing an excellent bandwidth (10MHz) and slew rate of 7V/us. The op-amps are unity gain stable and feature an ultra-low input bias current.

The devices are ideal for sensor interfaces, active filters and portable applications. The RS721 is specified at the full temperature range of -40°C to $+125^{\circ}\text{C}$ under single supplies of 2.5V to 5.5V or dual power supplies of $\pm 1.25\text{V}$ to $\pm 2.75\text{V}$.

PIN CONFIGURATIONS

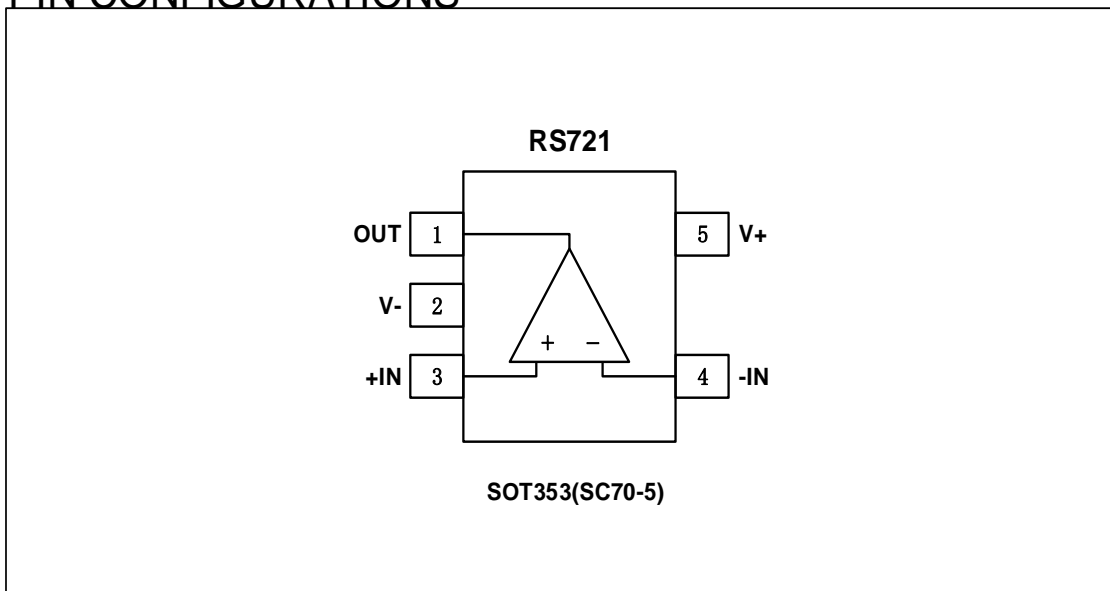

ABSOLUTE MAXIMUM RATINGS ⁽¹⁾

Supply Voltage, V+ to V-	7.0V
Input Terminals, Voltage ⁽²⁾	- 0.5 to (V+) + 0.5V
Current ⁽²⁾	±10mA
Storage Temperature	-65°C to +150°C
Operating Temperature	-40°C to +125°C
Junction Temperature	150°C
Package Thermal Resistance @ T _A = +25°C	
SOT23-5, SOT23-6	200°C/W
MSOP-10, SOIC-8	150°C/W
SOIC-14, TSSOP-14	100°C/W
Lead Temperature (Soldering, 10s)	260°C
ESD Susceptibility	
HBM	3000V
MM	200V



ESD SENSITIVITY CAUTION

ESD damage can range from subtle performance degradation to complete device failure. Precision integrated circuits may be more susceptible to damage because very small parametric changes could cause the device not to meet its published specifications.

- (1) Stresses above these ratings may cause permanent damage. Exposure to absolute maximum conditions for extended periods may degrade device reliability. These are stress ratings only, and functional operation of the device at these or any other conditions beyond those specified is not implied.
- (2) Input terminals are diode-clamped to the power-supply rails. Input signals that can swing more than 0.5V beyond the supply rails should be current-limited to 10mA or less.

PACKAGE/ORDERING INFORMATION

PRODUCT	ORDERING NUMBER	TEMPERATURE RANGE	PACKAGE LEAD	PACKAGE MARKING	PACKAGE OPTION
RS721	RS721XC5	-40°C~125°C	SOT353(SC70-5)	RS721	Tape and Reel,3000

ELECTRICAL CHARACTERISTICS

 (At $T_A = +25^\circ\text{C}$, $V_S=5\text{V}$, $R_L = 10\text{k}\Omega$ connected to $V_S/2$, and $V_{OUT} = V_S/2$, unless otherwise noted.)

PARAMETER		CONDITIONS	T_J	RS721			UNIT
				MIN	TYP	MAX	
POWER SUPPLY							
V_S	Operating Voltage Range		25°C	2.5		5.5	V
I_Q	Quiescent Current/Amplifier		25°C		1.15	1.55	mA
PSRR	Power-Supply Rejection Ratio	$V_S = 2.5\text{V to } 5.5\text{V}$ $V_{cm} = (V-) + 0.5\text{V}$	25°C	77	90		dB
			$-40^\circ\text{C to } 125^\circ\text{C}$	68			
INPUT							
V_{os}	Input Offset Voltage	$V_{cm} = 2.5\text{V}$	25°C		± 1	± 3	mV
$V_{os\ TC}$	Input Offset Voltage Average Drift	$-40^\circ\text{C to } 125^\circ\text{C}$			2.6		$\mu\text{V}/^\circ\text{C}$
I_B	Input Bias Current		25°C		1	10	pA
I_{os}	Input Offset Current		25°C		1	10	pA
V_{cm}	Common-Mode Voltage Range	$V_S = 5.5\text{V}$	25°C	-0.1		5.6	V
CMRR	Common-Mode Rejection Ratio	$V_S = 5.5\text{V}$, $V_{cm} = -0.1\text{V to } 4\text{V}$	25°C	77	90		dB
			$-40^\circ\text{C to } 125^\circ\text{C}$	70			
			25°C	63	80		
			$-40^\circ\text{C to } 125^\circ\text{C}$	60			
OUTPUT							
AOL	Open-Loop Voltage Gain	$R_L = 2\text{k}\Omega$, $V_o = 0.15\text{V to } 4.85\text{V}$	25°C	96	105		dB
			$-40^\circ\text{C to } 125^\circ\text{C}$	75			
			25°C	100	110		
			$-40^\circ\text{C to } 125^\circ\text{C}$	77			
	Output Swing From Rail	$R_L = 2\text{k}\Omega$	25°C		52		mV
		$R_L = 10\text{k}\Omega$	25°C		7		
I_{out}	Output Short-Circuit Current		25°C		150		mA
FREQUENCY RESPONSE							
SR	Slew Rate		25°C		7		V/ μs
GBP	Gain-Bandwidth Product		25°C		10		MHz
Φ_m	Phase Margin		25°C		62		$^\circ$
t_s	Settling Time, 0.1%				0.2		μs
	Overload Recovery Time	$V_{IN} \cdot \text{Gain} \geq V_S$			0.35		μs
NOISE							
e_n	Input-Referred Voltage Noise	$f = 1\text{ kHz}$	25°C		9.5		$\text{nV}/\sqrt{\text{Hz}}$
		$f = 10\text{ kHz}$	25°C		6.5		$\text{nV}/\sqrt{\text{Hz}}$

TYPICAL CHARACTERISTICS

At $T_A = +25^\circ\text{C}$, $V_S = 5\text{V}$, $R_L = 10\text{k}\Omega$ connected to $V_S/2$, $V_{OUT} = V_S/2$, unless otherwise noted.

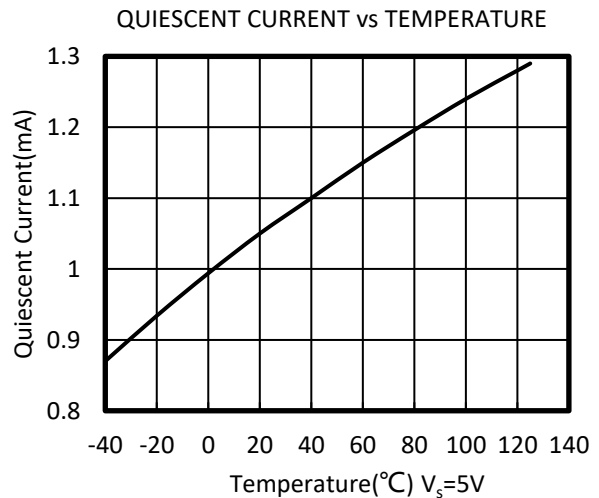
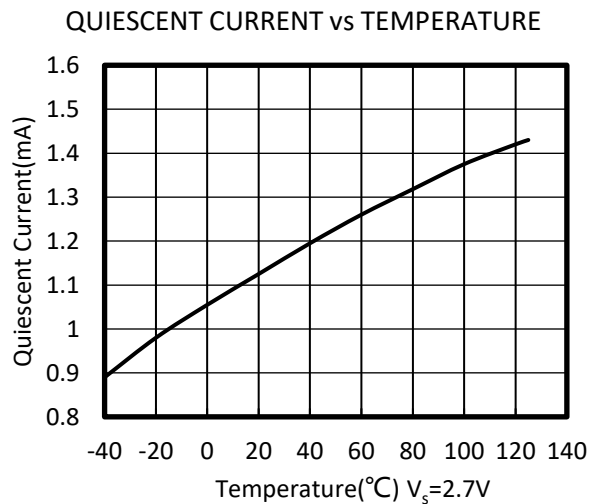
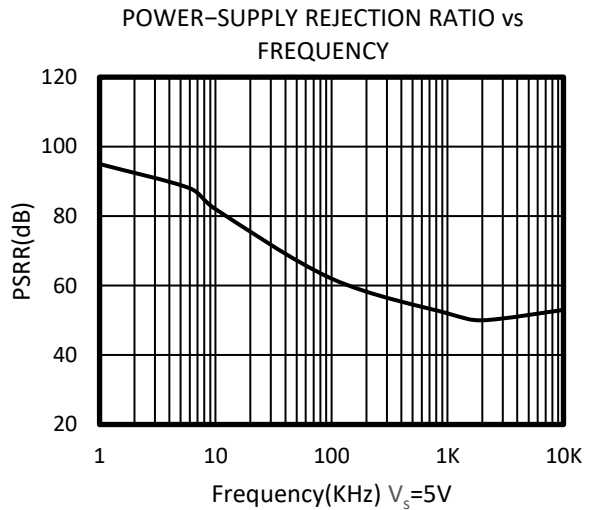
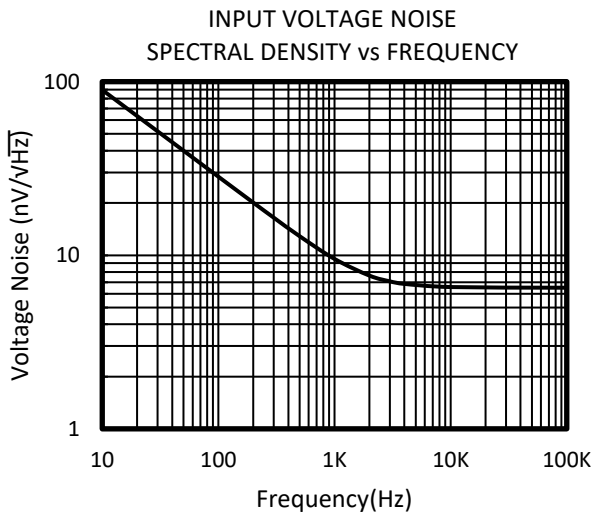
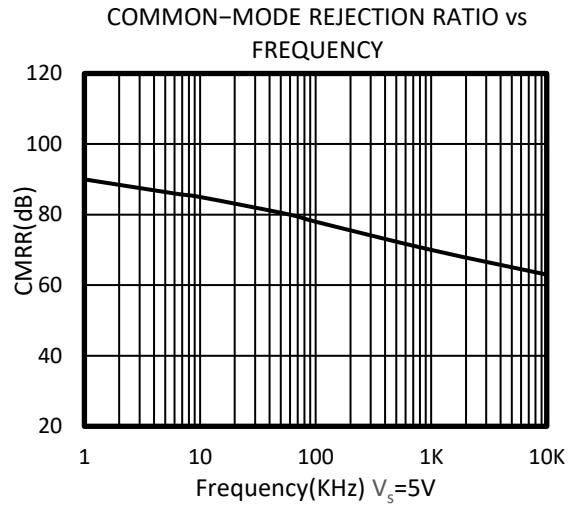
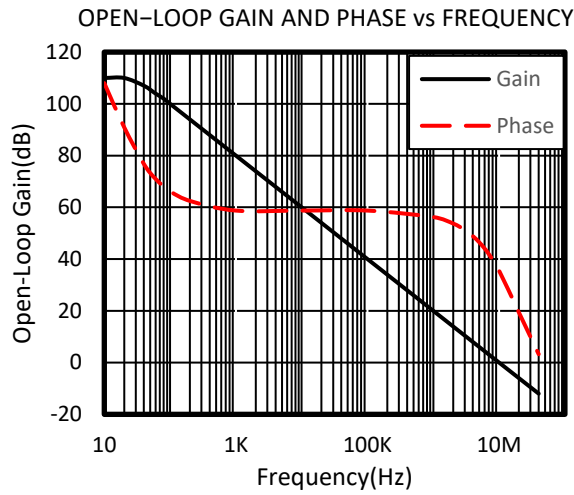

TYPICAL CHARACTERISTICS

At $T_A = +25^\circ\text{C}$, $V_S = 5\text{V}$, $R_L = 10\text{k}\Omega$ connected to $V_S/2$, $V_{OUT} = V_S/2$, unless otherwise noted.

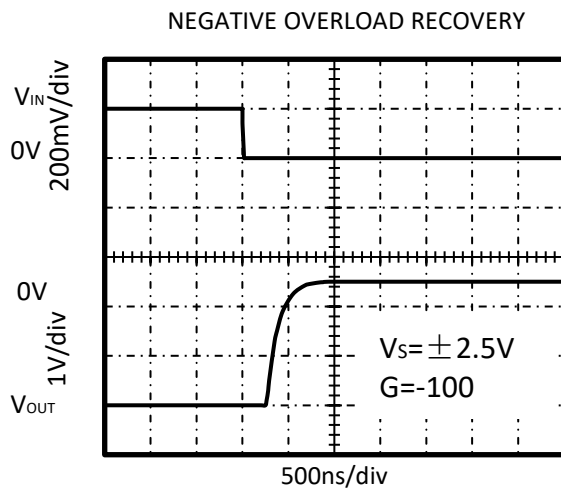
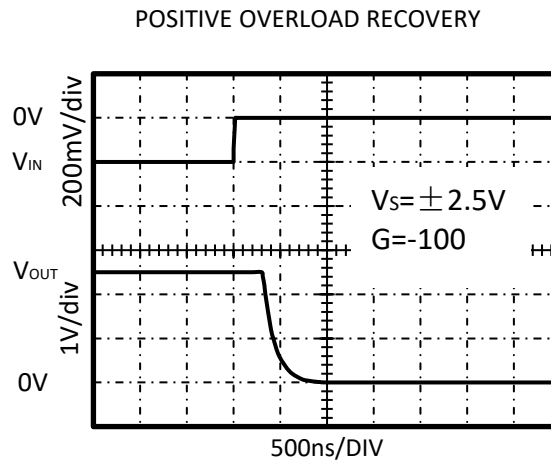
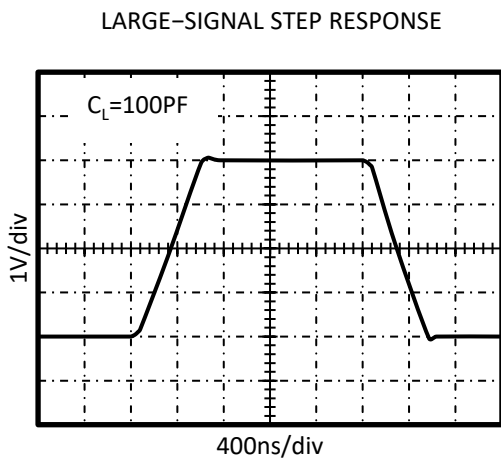
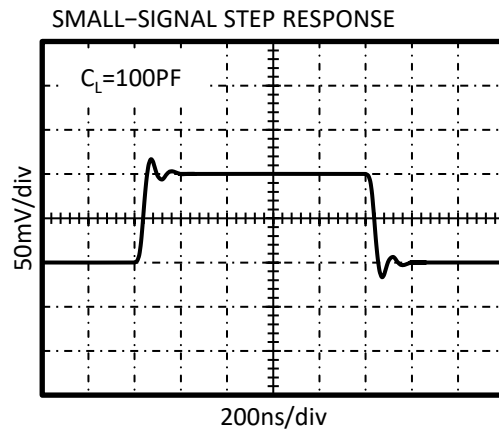
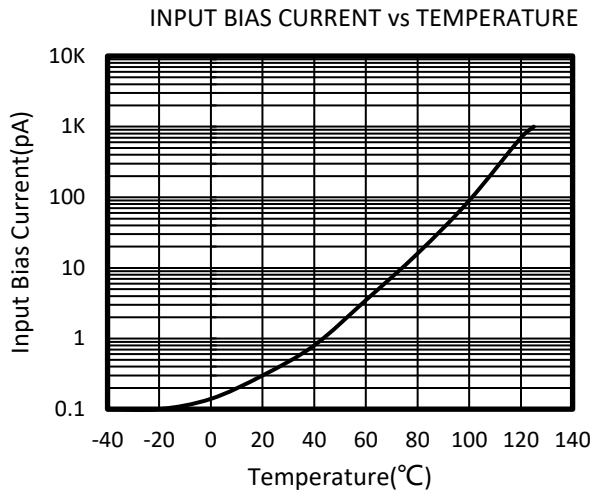

PACKAGE OUTLINE DIMENSIONS SOT353 (SC70-5)

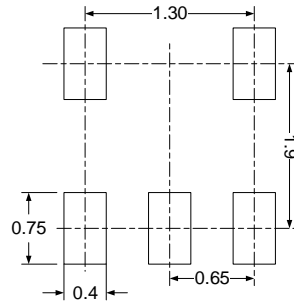
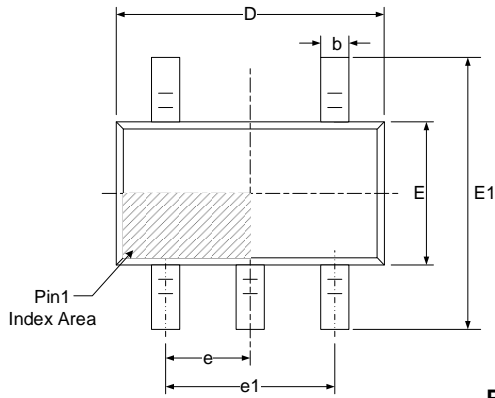

RECOMMENDED LAND PATTERN (Unit: mm)

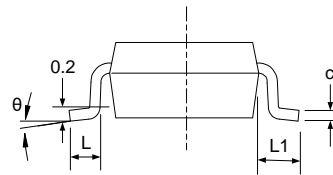
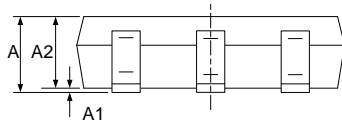

Symbol	Dimensions In Millimeters		Dimensions In Inches	
	Min	Max	Min	Max
A	0.900	1.100	0.035	0.043
A1	0.000	0.100	0.000	0.004
A2	0.900	1.000	0.035	0.039
b	0.150	0.350	0.006	0.014
c	0.080	0.150	0.003	0.006
D	2.000	2.200	0.079	0.087
E	1.150	1.350	0.045	0.053
E1	2.150	2.450	0.085	0.096
e	0.650(BSC)		0.026(BSC)	
e1	1.300(BSC)		0.051(BSC)	
L	0.260	0.460	0.010	0.018
L1	0.525		0.021	
θ	0°	8°	0°	8°