

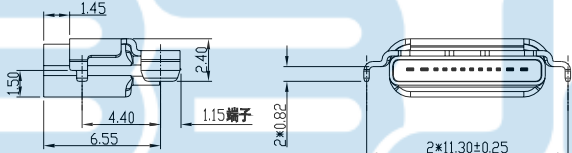

REV.	ECN	DESCRIPTION	MDF'D	DATE
REV1		DESCRIPTION1		

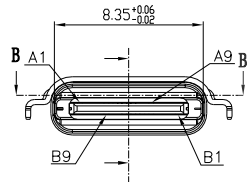

- NOTES:**
- MATERIAL:**
 - HOUSING:SEE TABLE ORDERING INFORMATION
 - CONTACTS:Copper Alloy(C7025)
 - SHELL:Stainless steel
 - ELECTRICAL CHARACTERISTICS:**
 - CONTACT RESISTANCE:40mΩ Max FOR INTIAL.10mΩ CHANGE AFTER TEST. MEASURE at 20mv, 100mA.
 - CONTACT CURRENT RATING:3A FOR VBUS PIN;1.25A FOR VCONN and GND PIN;0.25A FOR all THE OTHER PIN.
 - CLTAGE RATING:30V
 - DIELECTRIC WITHSTANDING VOLTAGE:100 V R.M.S.
 - INSULATION RESISTANCE 100 MEGOHMS MIN
 - MECHANICAL PERFORMANCE:**
 - INSERT FORCE:0.51-2.04Kg
 - EXTRACT FORCE:0.82-2.04Kg
 - AFTER DURABILITY:0.61-2.04Kg
 - DURABILITY:10000 CYCLES
 - ENVIRONMENTAL:**
 - OPERATION TEMPERATURE : -20°C to +85°C

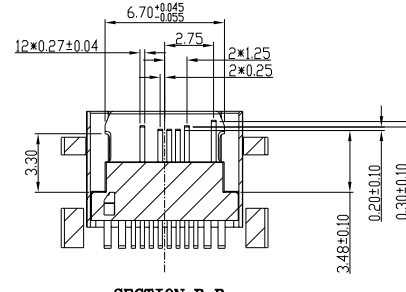
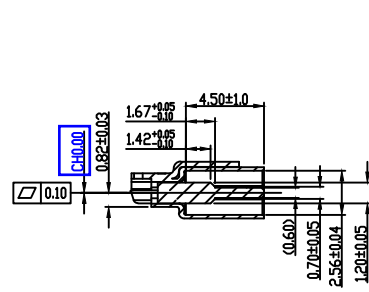
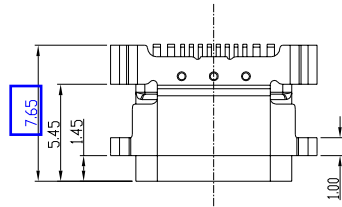
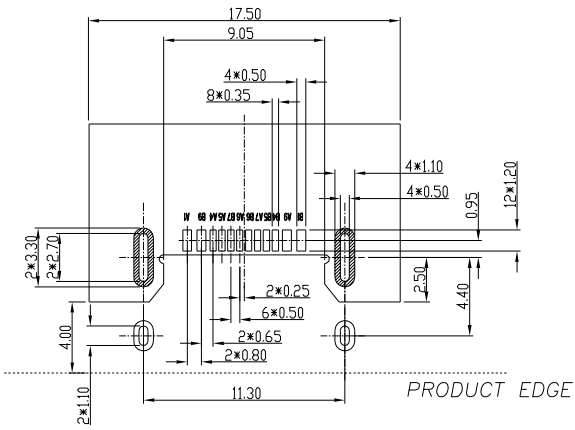
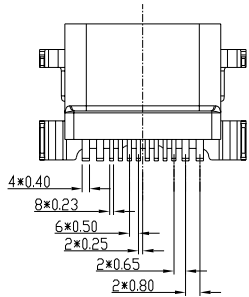
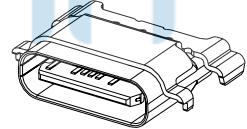

A12	A11	A10	A9	A8	A7	A6	A5	A4	A3	A2	A1
			VBUS		D-	D+	Vconn	VBUS			GND
GND			VBUS	Vconn	D+	D-		VBUS			
B1	B2	B3	B4	B5	B6	B7	B8	B9	B10	B11	B12
5	中间片		-----		1PCS	SUS304-1/2H		T=0.15mm, 素材			
4	护套壳子		-----		1PCS	SUS304-1/2H		T=0.30mm镀镍, 盐雾48H最小			
3	MODING弹子		-----		2PCS	LCP/G7025		LCP黑色, 半金雾锡1U"			
2	端子		-----		2PCS	C7025		T=0.15mm镀半金锡1U"			
1	拉伸壳子		-----		1PCS	SUS316L		T=0.20mm镀镍			
No.	Part Name		Part No.		QTY	Material		Remark			



GENERAL TOLERANCES: (UNLESS SPECIFIED)		PROJECTION						深圳市步步精科技有限公司 TITLE: TYPE-C 12P座防水拉伸壳带护套L=7.65mm CH=0 SMT沉板1.5mm PART NO: UC.01.36-1J-0001 0395-1			
MILLIMETERS	INCH	D.R.	DATE								
. = ±.25	. = ±.0150	HMY	DATE	SCALE:	1:1						
.X = ±.20	.X = ±.0098	CH.K	DATE	REV:	A						
.XX = ±.15	.XX = ±.0059	LYX	DATE	SH,T NO:	10F1						
.XXX = ±.05	.XXX = ±.0020	APV.D	DATE								
X* = ±2*	X* = ±*	LJP	DATE								
X.X* = ±1*	X.X* = ±1*										

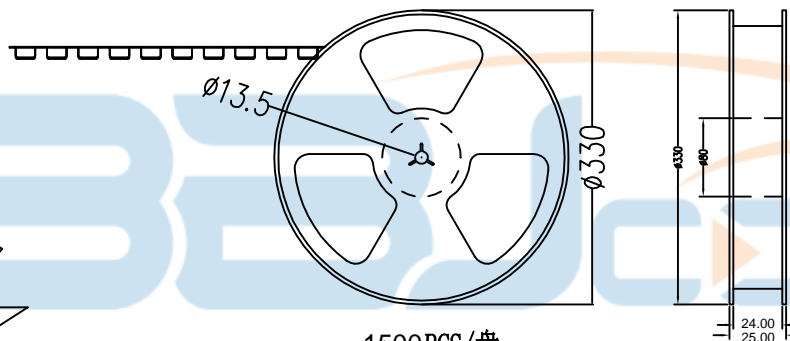
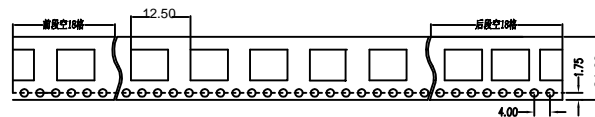
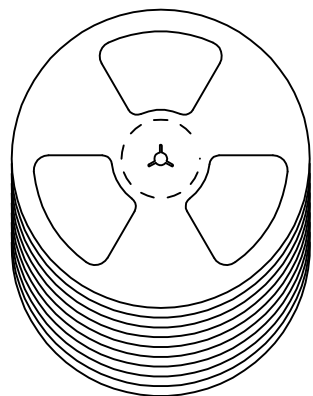

1500PCS/盘

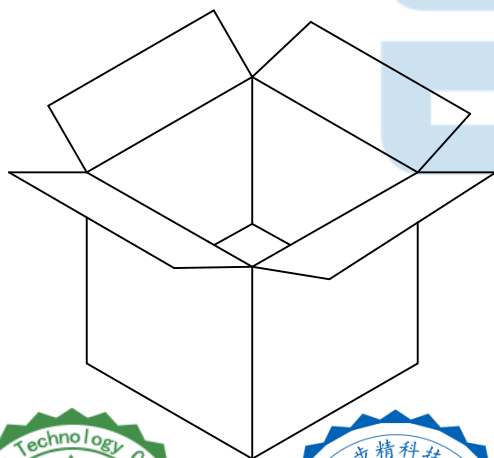

备注:

1. 包装数量: 1500 CS/盘, 10盘/箱或15盘/箱
2. 包装带长度: 每盘前后各空10-20个空格, 中间包装.
3. 材质:
 - 载体: 聚丙烯 (PS), 抗阻 $10^{6-9} \Omega$
 - 上带: 聚乙烯 (PET), 抗阻 $10^{6-11} \Omega$
 - 卷盘: 聚苯乙烯.

纸箱规格: 345*345*23mm

纸箱规格: 345*345*35mm

	一般公差		比例 SCALE	N/A	绘图 DRAWN	HMY	TITLE: TYPE-C 12P母座防水拉伸壳带护套L=7.65mm CH=0 SMT沉板1.5mm	版次 REV. 1.0
	XX. ±	XXX. ±						
	.X ± 0.25	.XXX ±	尺寸 SIZE	A4	核准 APPROVE	LJP		
	.XX ± 0.10	X.* ± 2'						
.XXX ± 0.05	.X.* ± 0.5'							