



ORIENT

Photo coupler Product

Data Sheet

Part Number: OR-10XX

Customer: _____

Date: _____

SHENZHEN ORIENT COMPONENTS CO., LTD

Block A 3rd Floor No.4 Building, Tian'an Cyber Park, Huangge Rd, LongGang Dist, Shenzhen, GD

TEL: 0755-29681816

FAX: 0755-29681200

www.orient-opto.com

1. Features

- (1) Current transfer ratio: (CTR: 50~600% at $I_F = 5\text{mA}$, $V_{CE} = 5\text{V}$)
(CTR: 63~320% at $I_F = 10\text{mA}$, $V_{CE} = 5\text{V}$)
- (2) High input-output isolation voltage ($V_{iso} = 5,000\text{Vrms}$)
- (3) High collector-emitter voltage ($V_{CEO} = 80\text{V}$)
- (4) Temperature range $-55\text{ }^\circ\text{C}$ to $110\text{ }^\circ\text{C}$
- (5) Creepage distance $> 8\text{mm}$
- (6) Employs double transfer mold technology
- (7) Long Mini-flat package : 2.3mm profile :OR-10XX series
- (8) Safety approval
 - UL approved(No.E323844)
 - VDE approved(No.40029733)
 - CQC approved (No.CQC18001190940)
- (9) In compliance with RoHS, REACH standards
- (10) MSL Class I

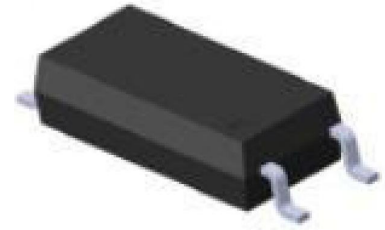

2. Description

The OR-10XX series devices consist of an infrared emitting diode, optically coupled to a photo transistor detector. They are packaged in a 4-pin SOP package.

3. Applications

- (1) Programmable controllers
- (2) System appliances, measuring instruments
- (3) Telecommunication equipments
- (4) Home appliances, such as fan heaters, etc.
- (5) Signal transmission between circuits of different potentials and impedances

4. Functional Diagram

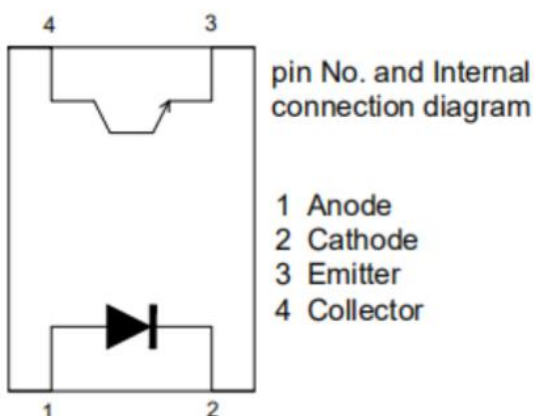

5. Absolute Maximum Ratings (Ta=25°C)

Parameter		Symbol	Rated Value	Unit
Input	Forward Current	I_F	60	mA
	Junction Temperature	T_J	125	°C
	Reverse Voltage	V_R	6	V
	Consume Power	P	100	mW
Output	Collector and emitter Voltage	V_{CEO}	80	V
	Emitter and collector Voltage	V_{ECO}	7	
	Collector Current	I_C	50	mA
	Consume Power	P_C	150	mW
Total Consume Power		P_{tot}	250	mW
*1	Insulation Voltage	V_{iso}	5000	Vrms
Working Temperature		T_{opr}	-55 to + 110	°C
Deposit Temperature		T_{stg}	-55 to + 125	
*2	Soldering Temperature	T_{sol}	260	

Notes:

*1 AC for 1 minute, R.H.= 40 ~ 60% R.H. In this test, pins 1, 2 are shorted together, and pins 3, 4 are shorted together.

* 2 For 10 seconds

6. Electrical Optical Characteristics at Ta=25°C

Parameter		Symbol	Min	Typ.*	Max	Unit	Condition
Input	Forward Voltage	V_F	---	1.25	1.6	V	$I_F=50\text{mA}$
	Reverse Current	I_R	---	---	5	μA	$V_R=5\text{V}$
	Collector capacitance	C_t	---	50	---	pF	$V=0, f=1\text{MHz}$
Output	Collector to emitter Current	I_{CEO}	---	10	100	nA	$V_{CE}=20\text{V},$ $I_F=0\text{mA}$
	Collector and Emitter attenuation Voltage	BV_{CEO}	80	---	---	V	$I_C=1\text{mA}$ $I_F=0\text{mA}$
	Emitter and Collector attenuation Voltage	BV_{ECO}	7	---	---	V	$I_E=0.1\text{mA}$ $I_F=0\text{mA}$
Transforming Characteristics	*1 Current conversion ratio	CTR	50	---	600	%	$I_F=5\text{mA}$ $V_{CE}=5\text{V}$
	Collector Current	I_C	2.5	---	30	mA	
	Collector and Emitter Saturation Voltage	$V_{CE(sat)}$	---	---	0.3	V	$I_F=10\text{mA}$ $I_C=1\text{mA}$
	Insulation Impedance	R_{iso}	10^{12}	---	---	Ω	DC500V 40~60%R.H.
	Floating Capacitance	C_f	---	0.3	---	pF	$V=0, f=1\text{MHz}$
	Response Time	t_r	---	3	18	μs	$V_{CC}=5\text{V},$ $I_C=2\text{mA}$ $R_L=100\Omega$
	Descend Time	t_f	---	4.7	18	μs	

*1 Current Conversion Ratio = $I_C / I_F \times 100\%$, CTR Tolerance: $\pm 3\%$.

7. Rank Table of Current Transfer Ratio

CTR Rank	Min.	Typ.	Max.	Unit	Condition
OR-1000	50	—	600	%	IF=5mA, V _{CE} =5V, Ta=25°C
OR-1001	100	—	160		
OR-1004	100	—	200		
OR-1005	50	—	150		
OR-1006	100	—	300		
OR-1007	80	—	160		
OR-1008	130	—	260		
OR-1009	200	—	400		
OR-1010	150	—	300		
OR-1019	250	—	500		
OR-1020	300	—	450		
OR-1002	22	—	—	%	IF=1mA, V _{CE} =5V, Ta=25°C
OR-1003	34	—	—		
OR-1014	56	—	—		
OR-1015	63	—	125		
OR-1018	100	—	200		
OR-1002	63	—	125	%	IF=10mA, V _{CE} =5V, Ta=25°C
OR-1003	100	—	200		
OR-1014	160	—	320		



8. Order Information

Part Number

OR-10XX-W-Y-Z

Note

XX = CTR Rank (00 , 01 ,02 ,03 ...18 ,19 , 20.)

W = Tape and reel option (TP or TP1).

Y = 'V' code for VDE safety (This options is not necessary).

Z = 'G' code for Halogen free.

* VDE Code can be selected.

Option	Description	Packing quantity
TP	Surface mount lead form (low profile) + TP tape & reel option	3000 units per reel
TP1	Surface mount lead form (low profile) + TP1 tape & reel option	3000 units per reel

9. Naming Rule

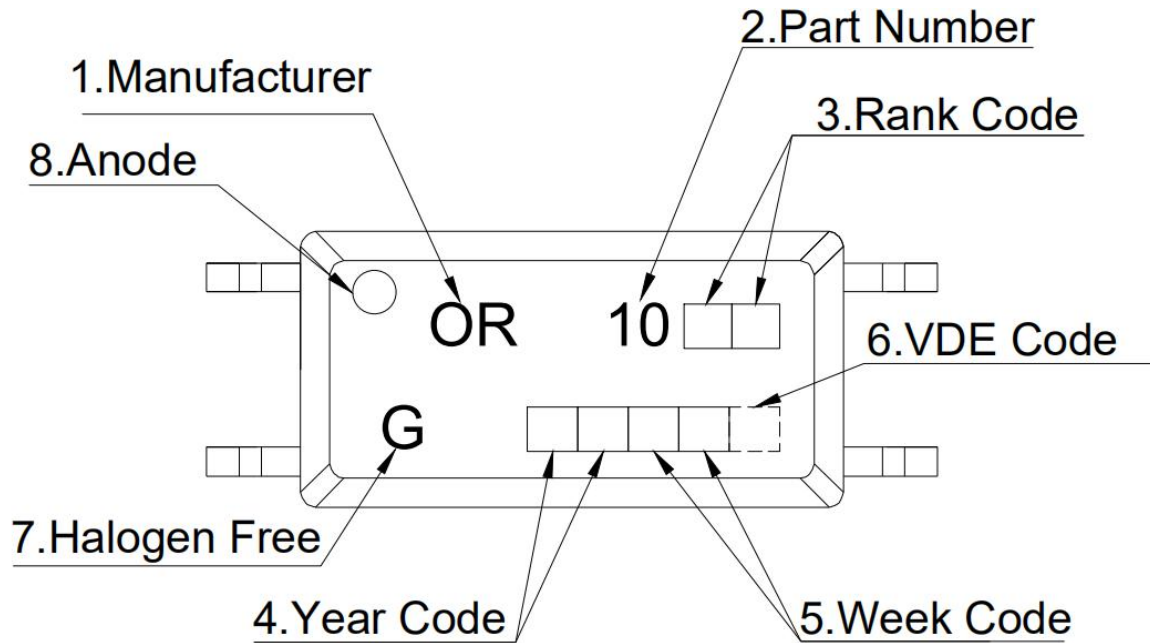

1. Manufacturer : ORIENT.
2. Part Number : 10XX.
3. Rank Code : CTR Rank
4. Year Code : '21' means '2021' and so on.
5. Week Code : 01 means the first week, 02 means the second week and so on.
6. VDE Code .
7. HF Code 'G': Halogen Free.
8. Anode.

* VDE Mark can be selected.

10.Package Dimension

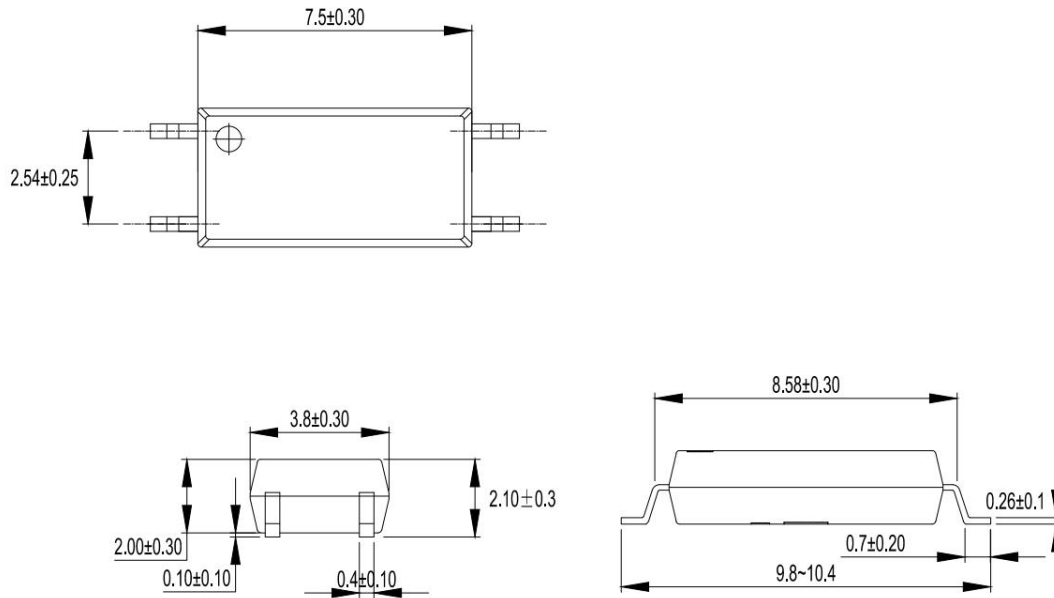

11.RRECOMMENDED FOOT PRINT PATTERNS (MOUNT PAD)

Unit:mm

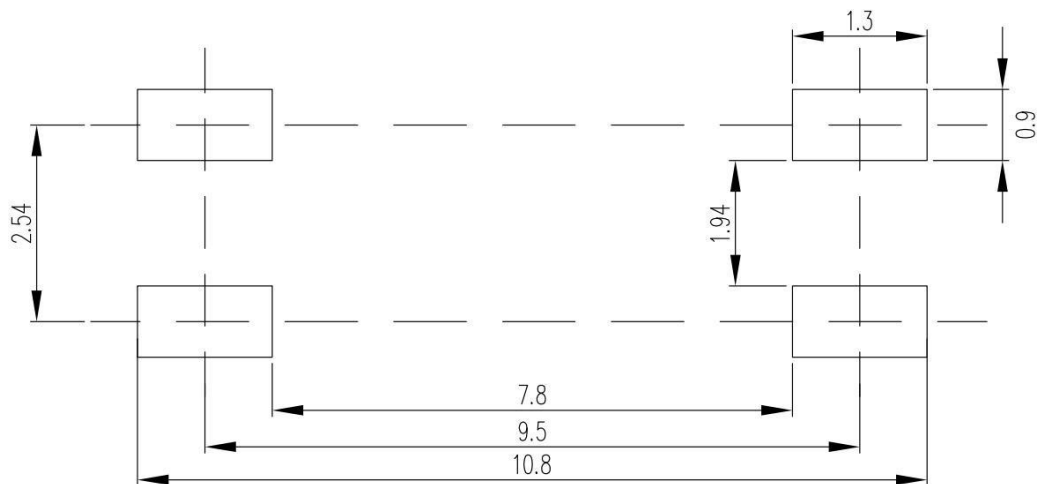

12. Taping Dimensions

(1) OR-10XX-TP

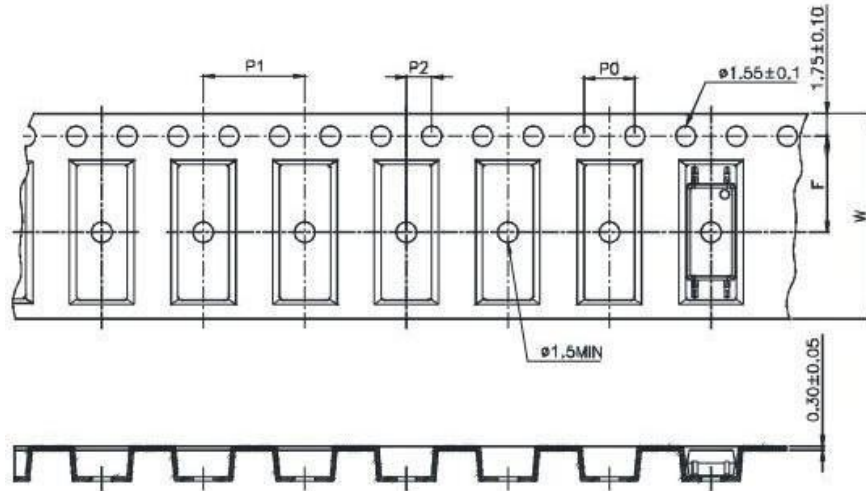

(2) OR-10XX-TP1

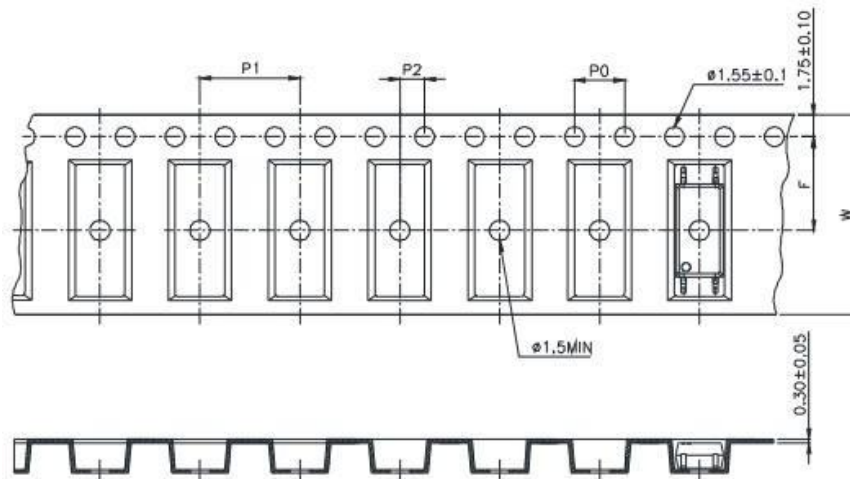

Description	Symbol	Dimension in mm (inch)
Tape wide	W	16±0.3 (0.63)
Pitch of sprocket holes	P ₀	4±0.3 (0.15)
Distance of compartment	F	7.5±0.1 (0.295)
	P ₂	2±0.1 (0.079)
Distance of compartment to compartment	P ₁	8±0.1 (0.315)

Package Type	TP/TP1
Quantities(pcs)	3000

13.Package Dimension

(1) package dimension

Packing Information	
Packing type	Reel type
Tape Width	16mm
Qty per Reel	3,000pcs
Small box (inner) Dimension	345*345*58.5mm
Large box (Outer) Dimension	620x360x360mm
Max qty per small box	6,000pcs
Max qty per large box	60,000pcs

(2)Packing Label Sample



Note:

1. P/N :Contents with "Order Information" in the specification.
2. LOT NO : The production lot.
3. BATCH : The Electrical rank.
4. Quantity :Packaging quantity.
5. Product Data :Date of manufacture.

14. Reliability Test

NO.	ITEMS	Reliability Testing				
		QTY. (Pcs)	Condition	Process	Device	Standard
1	RSH 耐焊接热	22	260±5℃	10s/3 次	锡炉	JESD22-A106
2	HTSL 高温存储	77	125℃	168 hrs	高温烤箱 测试仪	JESD22-A103
				500 hrs		
				1000 hrs		
3	LTSL 低温存储	77	-55℃	168 hrs	低温箱 测试仪	JESD22-A119
				500 hrs		
				1000 hrs		
4	TC 温度循环	77	H:125℃ 15min ∫ 5min L:-55℃ 15min	300 cycle	冷热冲击机	JESD22-A104
5	TS 温度冲击	77	H:100℃ 5min ∫ 15s L:-40℃ 5min	300 cycle	冷热冲击机	JESD22-A106
6	HTOL 高温操作	77	110℃ IF=10mA Vce=5V	168 hrs	高温烤箱 测试仪、老 化电路板	JESD22-A108
				500 hrs		
				1000 hrs		
7	ESD-HBM 人体模式	22	≥8KV 1Cycle	1次	ESD静电测 试仪	JESD22-A114
8	SD 可焊性	22	Pb-free 245±5℃	5S/1次	锡炉	JESD22-B102
9	HTRB 高温反向偏压	77	HTRB @125℃ Vce=80v	168 hrs	高温烤箱 , 测试仪	JESD22-A103
				500 hrs		
				1000 hrs		
10	H3TRB 温湿度反向偏 压, 寿命试验	77	H3TRB 85℃,85%RH Vce=80v	168 hrs	恒温恒湿 机, 测试仪	JESD22-A101
				500 hrs		
				1000 hrs		
11	Autoclave 压力锅	77	Ta=121 ℃,100%RH,2atm	96hrs	压力锅	JESD22-A102

15. Temperature Profile Of Soldering

(1) IR Reflow soldering (JEDEC-STD-020C compliant)

One time soldering reflow is recommended within the condition of temperature and time profile shown below. Do not solder more than three times.

Profile item	Conditions
Preheat	
- Temperature Min (T Smin)	150°C
- Temperature Max (T Smax)	200°C
- Time (min to max) (ts)	90±30 sec
Soldering zone	
- Temperature (TL)	217°C
- Time (t L)	60 sec
Peak Temperature	260°C
Peak Temperature time	20 sec
Ramp-up rate	3°C / sec max.
Ramp-down rate from peak temperature	3~6°C / sec
Reflow times	≤3

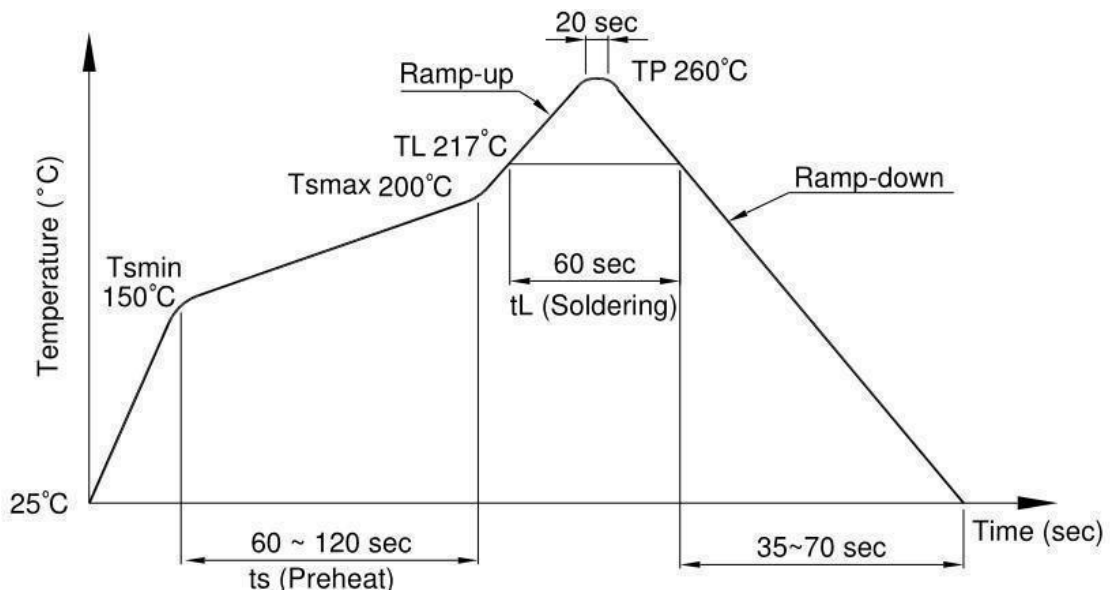

(2) Wave soldering (JEDEC22A111 compliant)

One time soldering is recommended within the condition of temperature.

Temperature	260+0/-5°C
Time	10 sec
Preheat temperature	25 to 140°C
Preheat time	30 to 80 sec

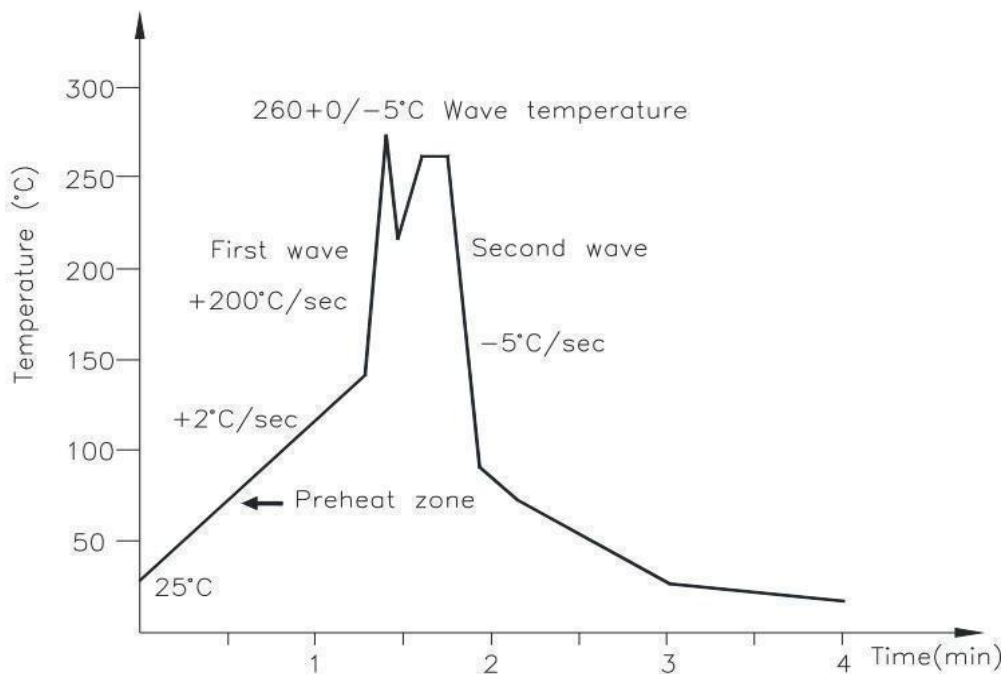

(3) Hand soldering by soldering iron

Allow single lead soldering in every single process. One time soldering is recommended.

Temperature	380+0/-5°C
Time	3 sec max

16.Characteristics Curves

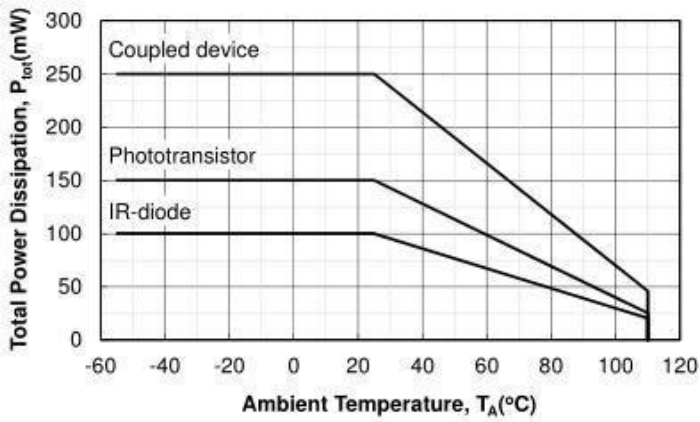

Figure 1. P_{tot} vs. T_A

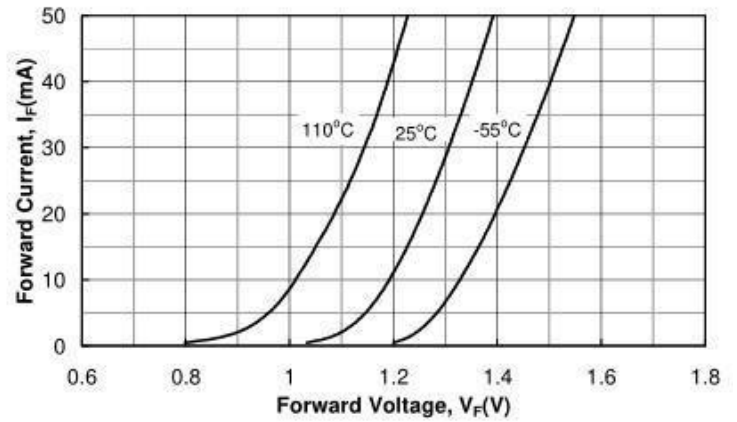

Figure 4. I_F vs. V_F

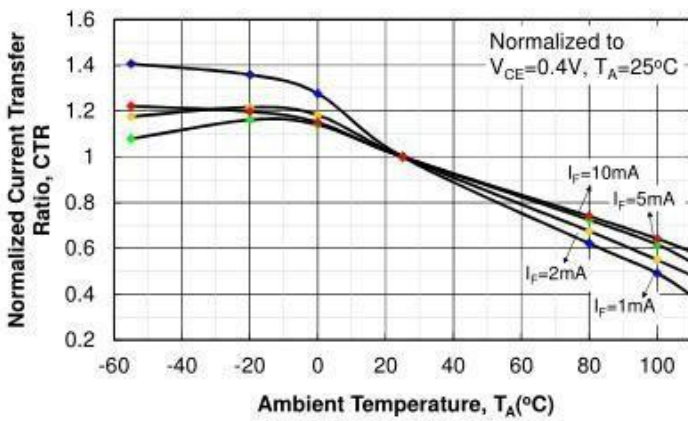

Figure 2. Saturated Normalized CTR vs. T_A

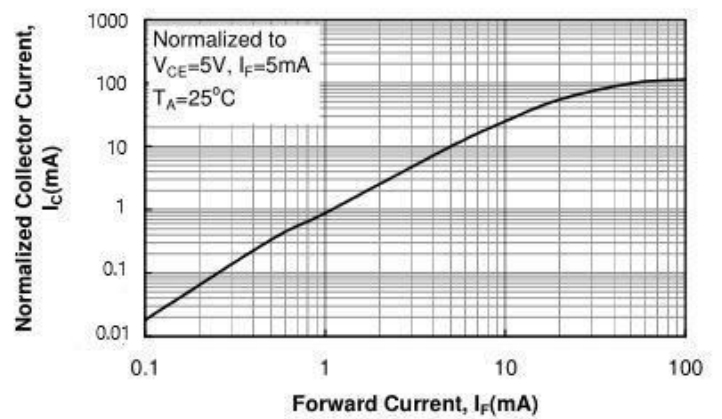

Figure 5. Normalized I_C vs. I_F

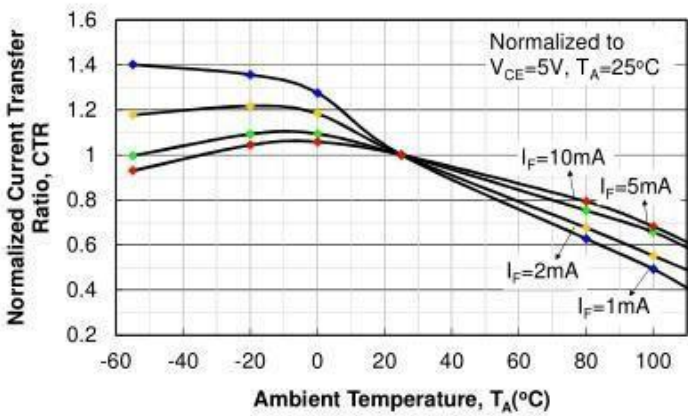

Figure 3. Non-saturated Normalized CTR vs. T_A

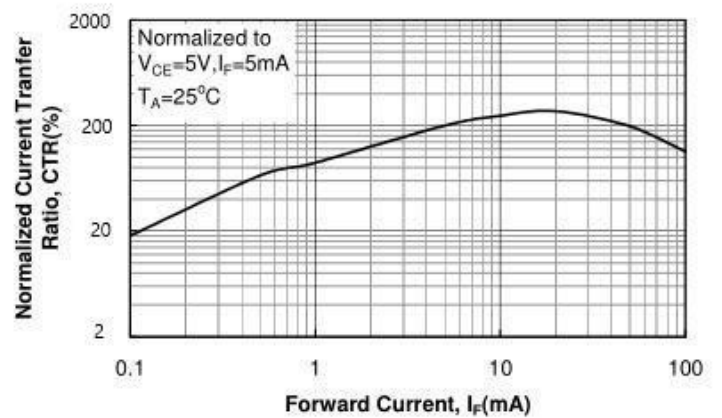

Figure 6. Normalized CTR vs. I_F

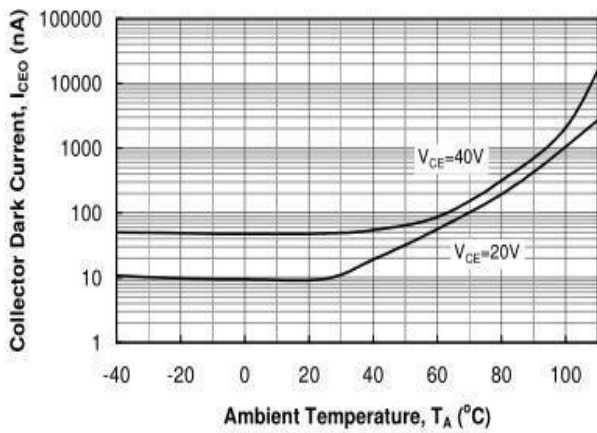

Figure 7. I_{CEO} vs. T_A

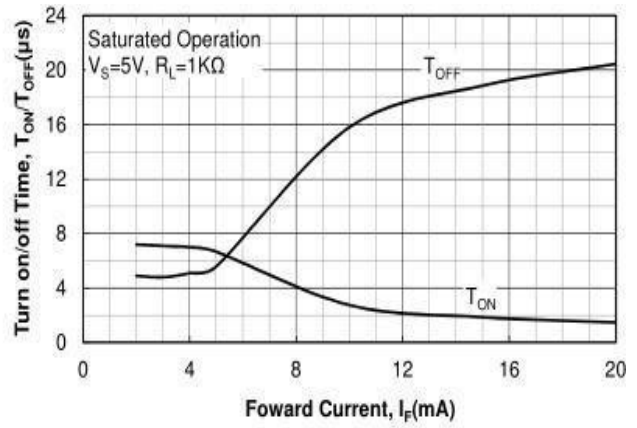

Figure 10. T_{ON} / T_{OFF} vs. I_F

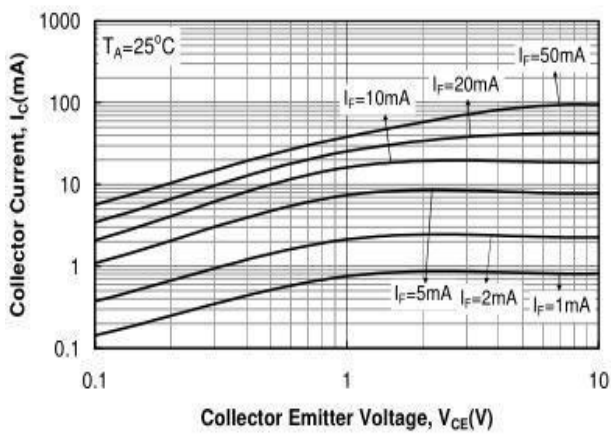

Figure 8. I_C vs. V_{CE}

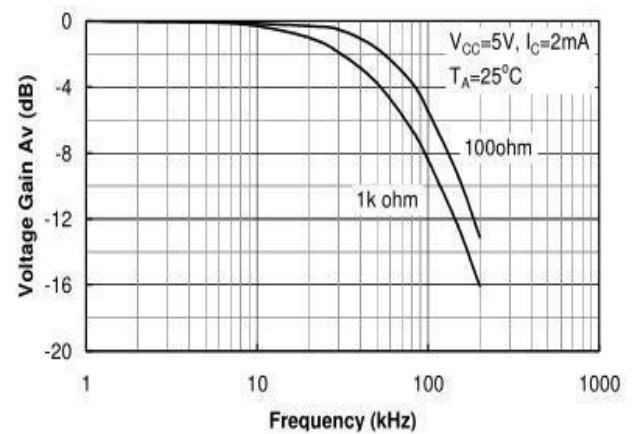

Figure 11. Frequency Response

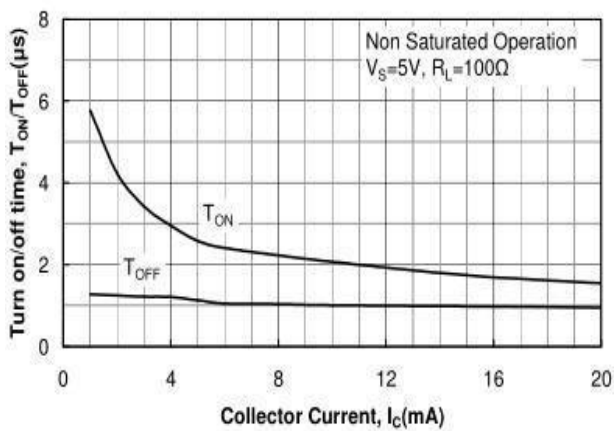

Figure 9. T_{ON} / T_{OFF} vs. I_C