

BAV199 Silicon Epitaxial Planar Diode

Low leakage switching double diode
For low leakage current applications

Feature

- Very low leakage current
- Medium speed switching times
- Series pair configuration

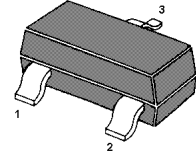
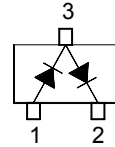

Marking Code: **PX**
SOT-23 Plastic Package

Absolute Maximum Ratings ($T_a = 25\text{ }^\circ\text{C}$)

Parameter	Symbol	Value	Unit
Peak Repetitive Reverse Voltage	V_{RRM}	85	V
Continuous Reverse Voltage	V_R	85	V
Continuous Forward Current	I_F	160	mA
Single Diode		140	
Repetitive Peak Forward Current	I_{FRM}	500	mA
Non-Repetitive Peak Forward Surge Current	I_{FSM}	at $t = 1\ \mu\text{s}$ 4	A
		at $t = 1\ \text{ms}$ 1	
		at $t = 1\ \text{s}$ 0.5	
Power Dissipation	P_D	250	mW
Thermal Resistance Junction to Ambient Air	$R_{\theta JA}$	500	$^\circ\text{C/W}$
Operating and Storage Temperature Range	T_j, T_{stg}	- 65 to + 150	$^\circ\text{C}$

Electrical Characteristics ($T_a = 25\text{ }^\circ\text{C}$)

Parameter	Symbol	Min.	Typ.	Max.	Unit
Reverse Breakdown Voltage at $I_R = 100\ \mu\text{A}$	$V_{(BR)R}$	85	-	-	V
Forward Voltage at $I_F = 1\ \text{mA}$ at $I_F = 10\ \text{mA}$ at $I_F = 50\ \text{mA}$ at $I_F = 150\ \text{mA}$	V_F	-	-	0.9	V
		-	-	1	
		-	-	1.1	
		-	-	1.25	
Reverse Current at $V_R = 75\ \text{V}$ at $V_R = 75\ \text{V}, T_j = 150\text{ }^\circ\text{C}$	I_R I_R	-	-	5 80	nA
Total Capacitance at $V_R = 0, f = 1\ \text{MHz}$	C_T	-	2	-	pF
Reverse Recovery Time at $I_F = I_R = 10\ \text{mA}, I_{rr} = 0.1 \times I_R, R_L = 100\ \Omega$	t_{rr}	-	-	3	μs

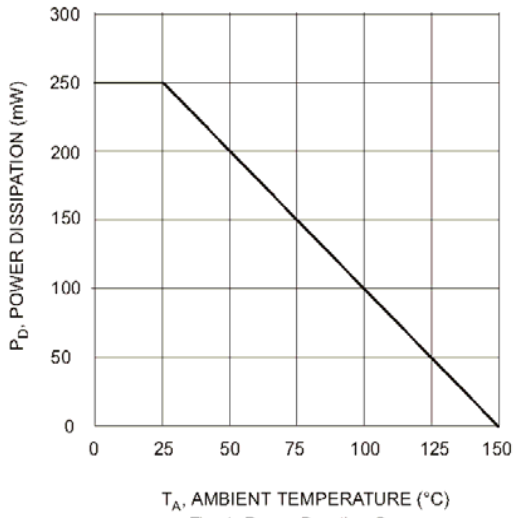

T_A , AMBIENT TEMPERATURE (°C)
Fig. 1 Power Derating Curve

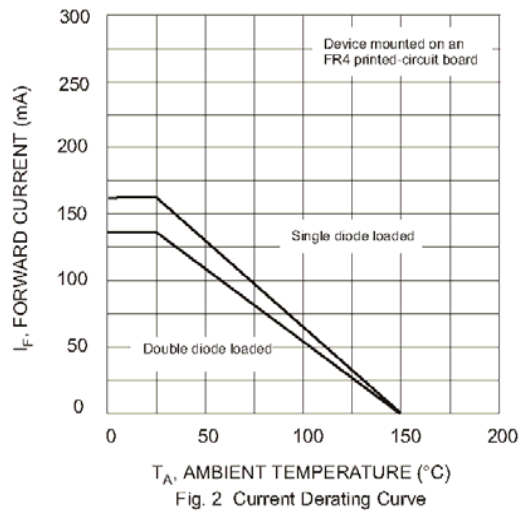

T_A , AMBIENT TEMPERATURE (°C)
Fig. 2 Current Derating Curve

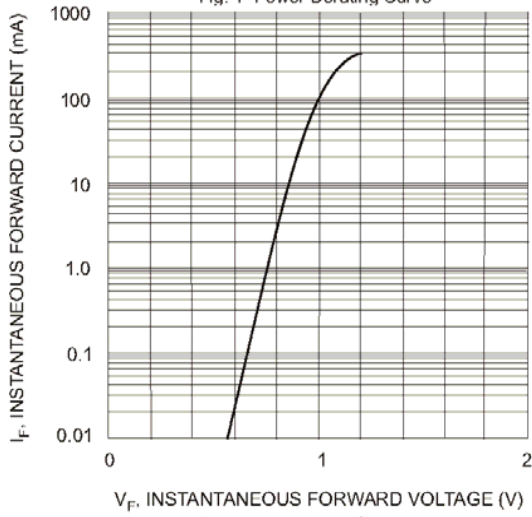

V_F , INSTANTANEOUS FORWARD VOLTAGE (V)
Fig. 3 Typical Forward Characteristics

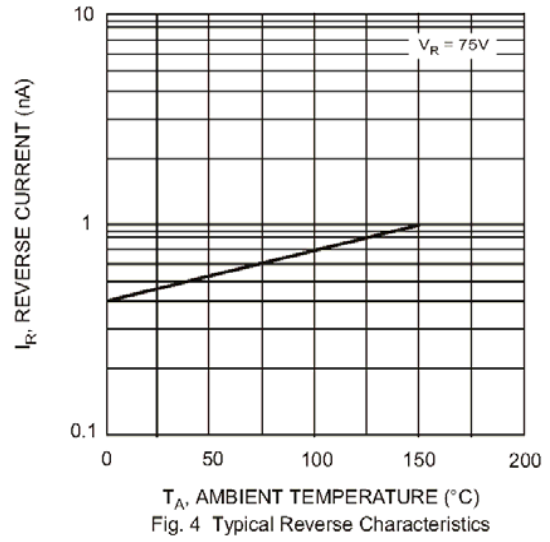

T_A , AMBIENT TEMPERATURE (°C)
Fig. 4 Typical Reverse Characteristics



PACKAGE OUTLINE

Plastic surface mounted package; 3 leads

SOT-23

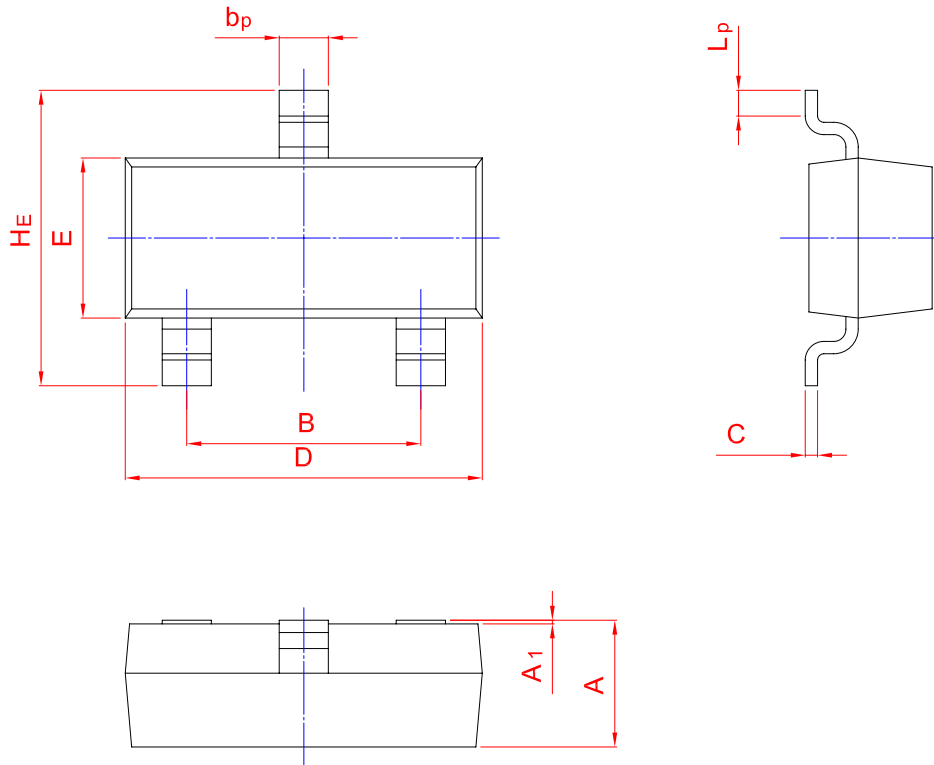
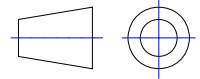

UNIT	A	B	bp	C	D	E	HE	A1	Lp
mm	1.40	2.04	0.50	0.19	3.10	1.65	3.00	0.100	0.50
	0.95	1.78	0.35	0.08	2.70	1.20	2.20	0.013	0.20