

Title		Mini-L0020	
Size	A3	Rev	A
Sheet	1 / 6	Drawn	Lu Weiwei
		Checked	Li Hongpeng
Data	2023.04.28	Approved	Chen Do



### Pins Remapping

PA0/SPI1\_NSS/I2S1\_WS/UART1\_RX/COMP1\_OUT/I2C1\_SCL/TIM3\_CH4/WKUP  
 PA1/SPI1\_MISO/I2S1\_MCK/LPTIM\_OUT/LPUART1\_TX/I2C1\_SDA/TIM3\_CH3  
 PA2/TIM16\_CH1N/TIM3\_CH2/ADC\_IN6/COMP1\_INF/COMP1\_INM0  
 PA3/UART1\_RX/TIM17\_CH1/COMP1\_OUT/ADC\_IN2/COMP1\_INM2/OPA1\_IN+  
 PA4/TIM16\_BKIN/UART1\_TX/LPTIM\_OUT/I2C1\_SDA  
 PA5/SPI1\_SCK/I2S1\_CK/TIM16\_CH1/TIM17\_CH1/I2C1\_SCL/TIM3\_CH4  
 PA6/SPI1\_MOSI/I2S1\_SD/TIM16\_CH1N/TIM17\_CH1/MCO/COMP1\_OUT/TIM3\_CH3  
 PA7/SPI1\_MISO/I2S1\_MCK/LPTIM\_OUT/TIM17\_CH1/MCO/TIM3\_CH2/ADC\_IN7/COMP1\_INP0/OPA2\_OUT  
 PA8/SPI1\_SCK/I2S1\_CK/LPTIM\_TRIG/TIM16\_CH1/MCO/TIM3\_CH1/COMP1\_INP1/OPA2\_IN-  
 PA9/SPI1\_MOSI/I2S1\_SD/TIM16\_CH1N/TIM17\_CH1N/TIM3\_ETR  
 PA10/nRST  
 PA11/TIM16\_CH1/TIM17\_CH1/TIM3\_CH1/ADC\_IN4/COMP1\_INM1/OPA1\_OUT  
 PA12/UART1\_TX/TIM17\_CH1N/ADC\_IN3/OPA1\_IN-  
 PA13/SWDIO/UART1\_RX/LPUART1\_RX/I2C1\_SCL  
 PA14/SWDCLK/UART1\_TX/SPI1\_MISO/I2S1\_MCK/TIM3\_CH2/BOOT0  
 PA15/SPI1\_NSS/I2S1\_WS/TIM3\_CH3/ADC\_IN6/COMP1\_INP2/OPA2\_IN+  
 PB0/TIM17\_BKIN/TIM16\_CH1/TIM3\_CH1/ADC\_IN1  
 PB1/TIM16\_CH1N/LPTIM\_TRIG/TIM3\_CH2/ADC\_IN0

PA0	NSS		RXD1	K2
PA1	MISO	SDA	TXD2	LD4
PA2				
PA3		OP1+	ADC1	K1
PA4			TXD1	LD3
PA5	SCLK	SCL		LD2
PA6			COMP_OUT	LD1
PA7		OP2_OUT	COMP_INP	
PA8		OP2-		
PA9	MOSI			
PA10	nRST			
PA11		OP1_OUT		
PA12		OP1-		
PA13		SWDIO	RXD2	
PA14		SWCLK		
PA15		OP2+	ADC0	
PB0				K3
PB1	BUZ			

### Peripheral

#### LED

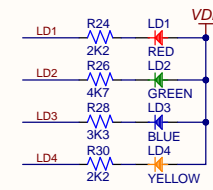

#### Key

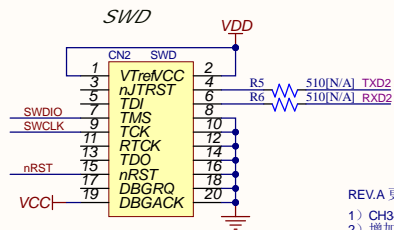
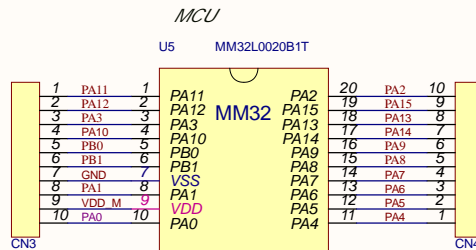
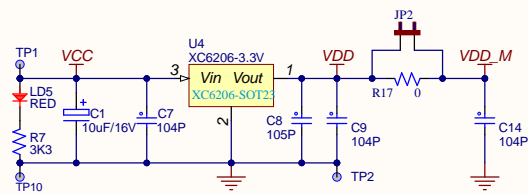
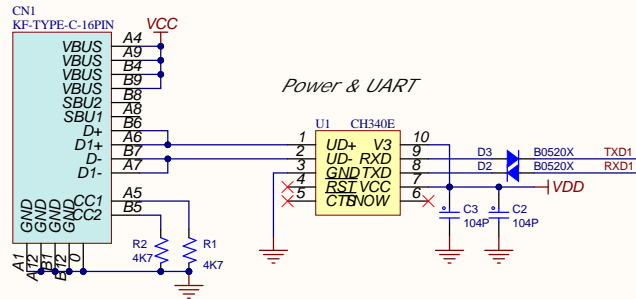
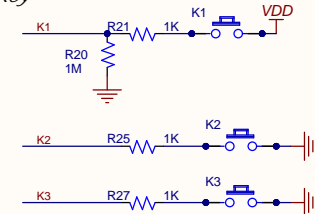

#### REV.A 更新记录

- 1) CH340E 和MCU的连接电阻更换成二极管
- 2) 增加了地线环测试点
- 3) 修正了光电二极管SL9302的PCB封装丝印

#### nRST

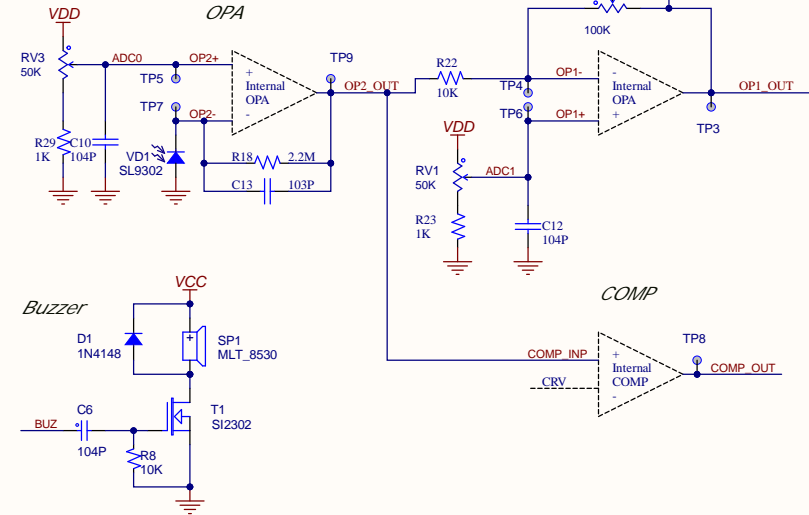
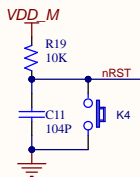

#### SPI Flash

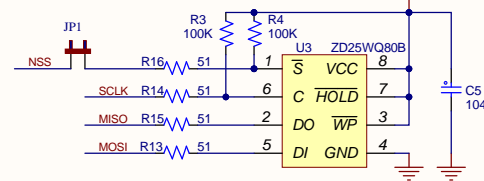

#### I2C

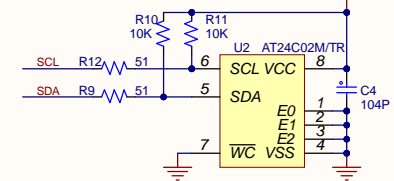

Title	Mini-L0020
Size	A3
Sheet	2
Date	2023.04.28
Rev	A
Drawn	Lu Weiwei
Checked	Li Hongpeng
Approved	Chen Do



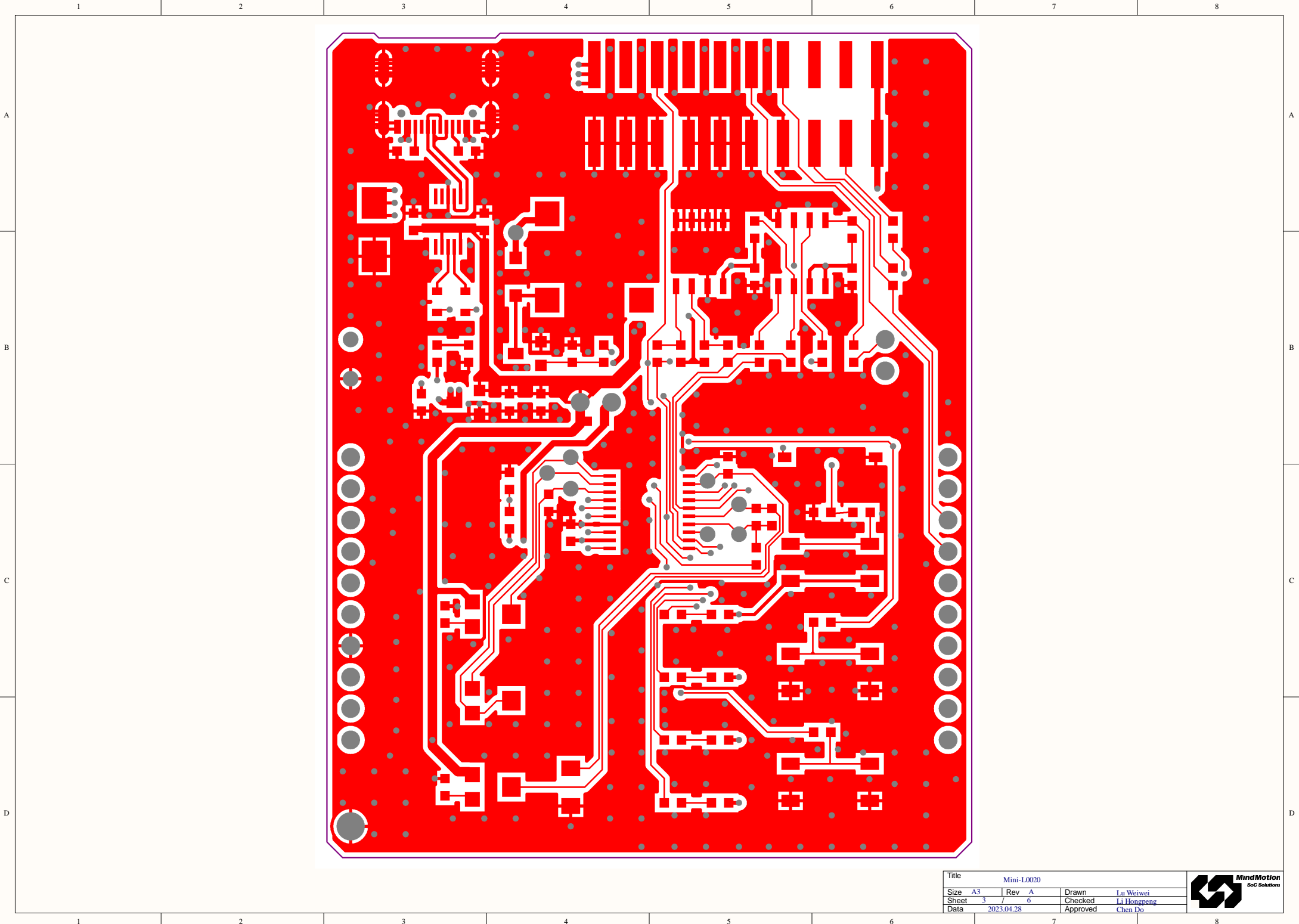

Title	Mini-L0020			
Size	A3	Rev	A	
Sheet	3	7	6	
Date	2023.04.28		Checked	Li Hongpeng
			Approved	Chen Do



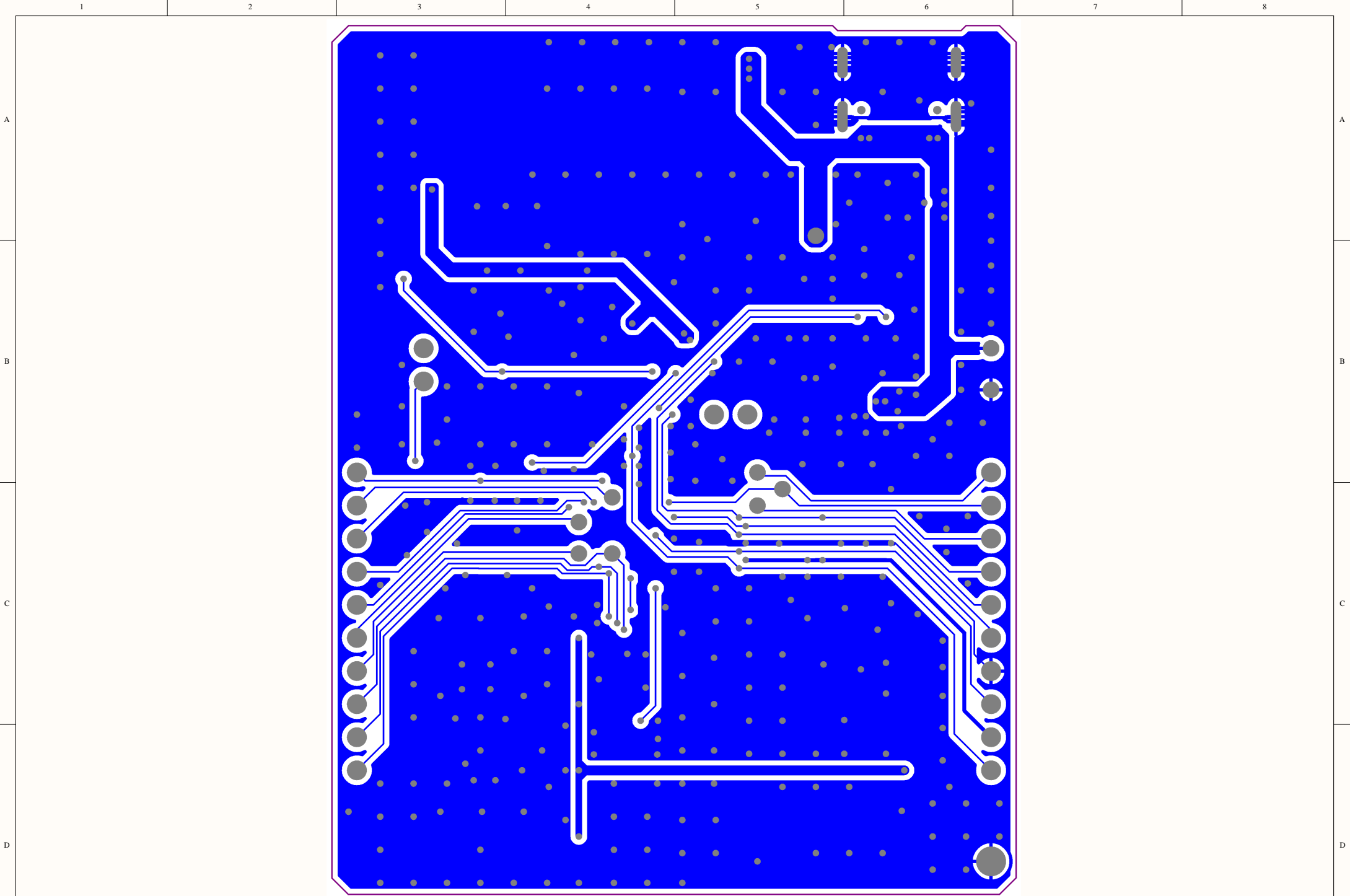

Title	Mini-L0020		
Size	A3	Rev	A
Sheet	4	/	6
Data	2023.04.28		Approved
	Drawn	Lu Weiwei	
	Checked	Li Hongpeng	
	Approved	Chen Do	



A

B

C

D

A

B

C

D

1

2

3

4

5

6

7

8

1

2

3

4

5

6

7

8





# MM32 MiniBoard

PA8 - -PA11  
PA7 - -PA12  
-PA15  
-PA6  
-PA3

**MB-078**  
Rev.A

**Mini-L0020**  
MM32L0020B1T

Title	Mini-L0020		
Size	A3	Rev	A
Sheet	6	Checked	Li Hongpeng
Date	2023.04.28	Approved	Chen Do

